

# Overview of Heavy Ion Fusion / High Energy Density Laboratory Physics \*

**B. Grant Logan**

**On behalf of the Heavy Ion Fusion Science  
Virtual National Laboratory\*\* (HIFS-VNL)\*\***

**LBL, LLNL, PPPL**

**Presentation in two parts:**

- 1. Heavy ion driven HEDP***
- 2. Heavy ion fusion potential***

**2007 Fusion Power Associates Annual Meeting**

**Oak Ridge, Tennessee**

**December 4-5, 2007**

\*This work was performed under the auspices of the U.S. Department of Energy by the University of California, Lawrence Berkeley and Lawrence Livermore National Laboratories under Contract Numbers DE-AC02-05CH1123 and DE-AC52-07NA27344 , and by the Princeton Plasma Physics Laboratory under Contract Number DE-AC02-76CH03073.

\*\* HIFS-VNL: A collaboration between Lawrence Berkeley National Laboratory, Lawrence Livermore National Laboratory, and Princeton Plasma Physics Laboratory, USA.

# Highlights of the US heavy ion fusion science program

---

- **Compressed intense heavy ion beams in neutralizing background plasma in NDCX-I: 150 ns down to 2 ns FWHM.**
- **Begun heavy-ion driven isochoric target heating experiments to 1 eV in joint experiments with GSI, Germany, to develop HEDP diagnostics.**
- **Unique diagnostic measurements of electron cloud effects on intense heavy-ion beam transport in both quadrupole and solenoid magnets.**
- **Computer simulation models that match the experimental results in both neutralized beam compression and e-cloud studies.**
- **ATA accelerator equipment sufficient for 3 to 6 MeV NDCX-II next step for both warm dense matter and ion direct drive target physics experiments.**
- **New LLNL Lasnex work on high gain HIF direct drive, and in-house capability to run HYDRA code for NDCX target design support, and to explore new heavy ion fusion direct drive target concept.**

# The HIFS-VNL pursues a unique approach to warm dense matter physics driven by intense, compressed ion beams

## Ion energy loss rate in targets

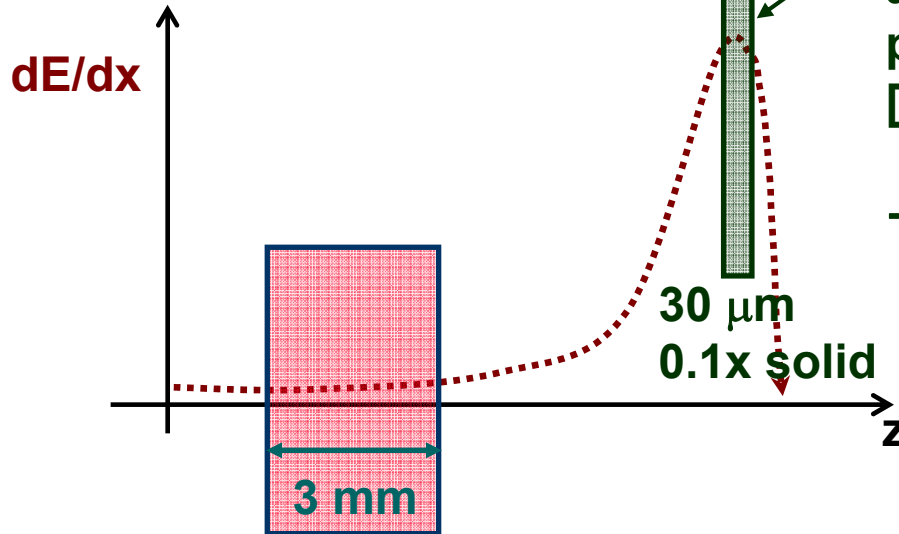

Maximum  $dE/dx$  and uniform heating at this peak require short ( $\sim 1$  ns) pulses to minimize hydro motion. [L. R. Grisham, Phys. Plasmas 11, 5727(2004)].

$\rightarrow$  Te  $\sim 0.5$  eV in NDCX-I by FY09,  
Te  $> 1$  eV in NDCX-II by FY10+  
Aluminum

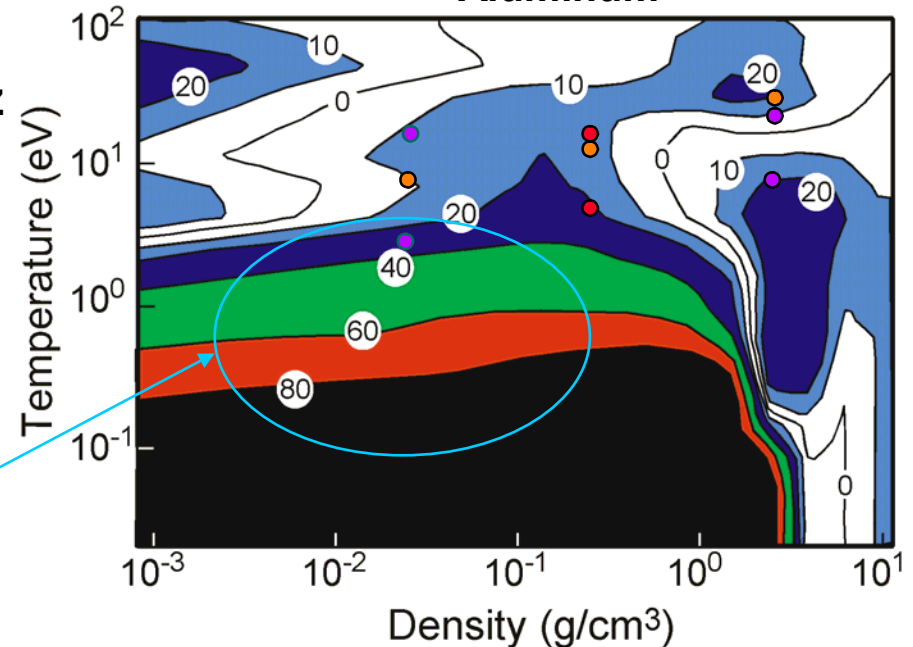

GSI: 40-100 GeV heavy ions  $\rightarrow$   
thick targets  $\rightarrow$  Te  $\sim 1$  eV per kJ

Dense, strongly coupled plasmas @  $10^{-2}$  to  $10^{-1}$  x solid density are potentially interesting areas to test EOS models (Numbers are % disagreement in EOS models where there is little or no data) (Courtesy of Richard W. Lee, LLNL)

**NDCX-I is being upgraded this year for first mm-scale warm dense matter experiments in FY08, initially below 5000 deg K.**

**NDCX-II, with 10X more beam energy using existing ATA induction nodules, is planned to be operational by 2010**

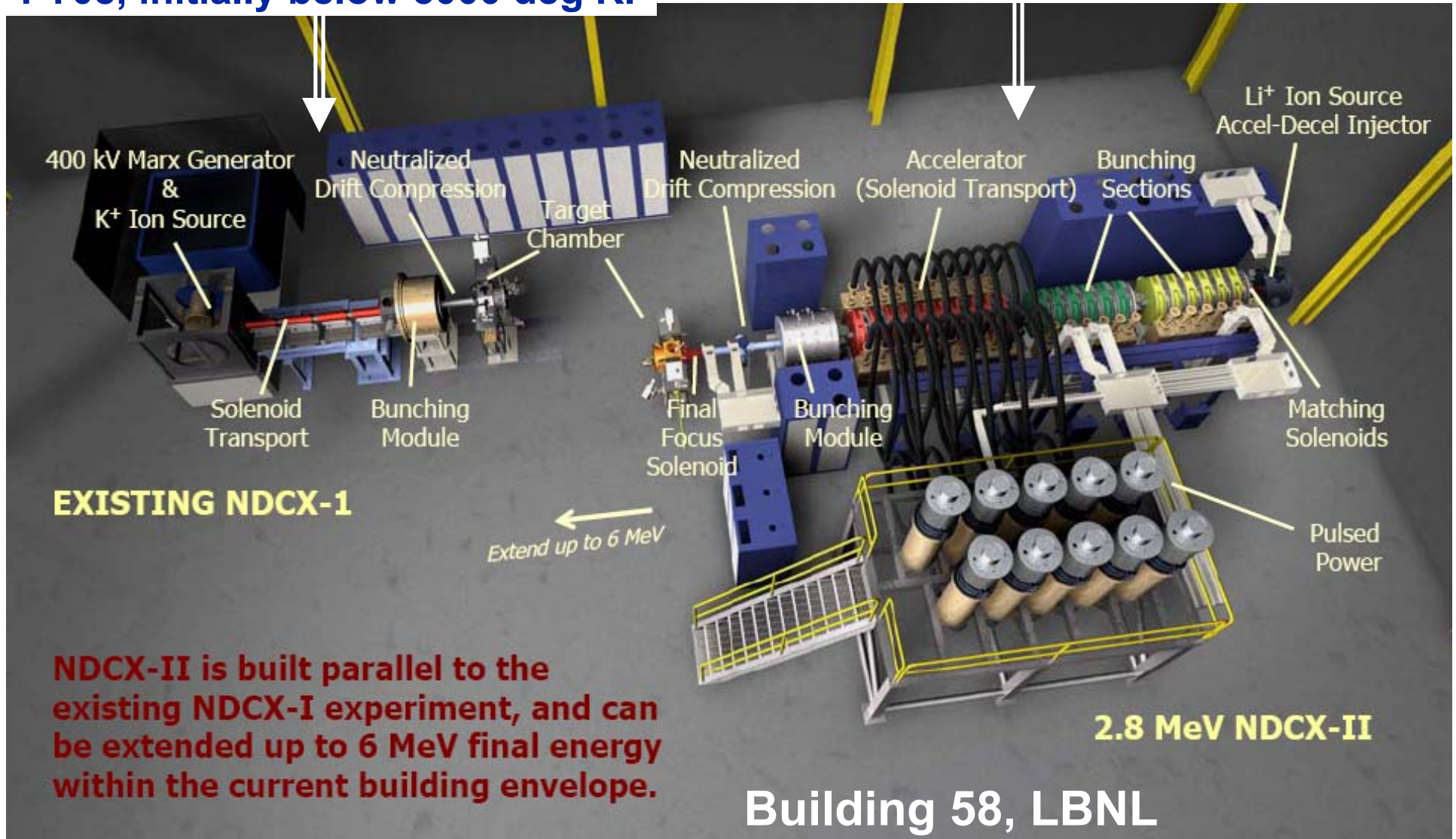

**NDCX-II is built parallel to the existing NDCX-I experiment, and can be extended up to 6 MeV final energy within the current building envelope.**

# Induction Bunching Module #1 from First Point Scientific using Astron cores

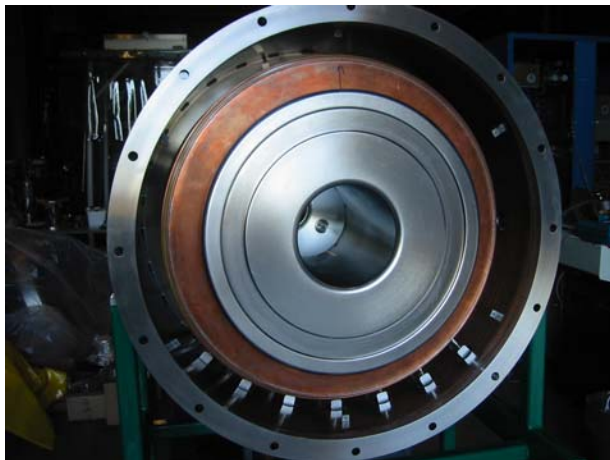
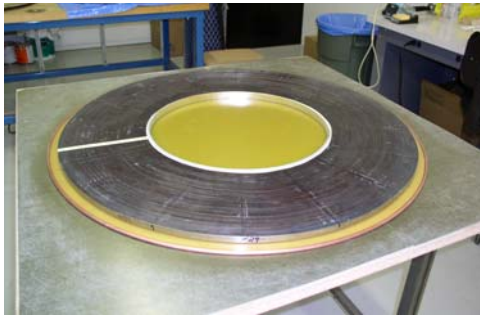

# The neutralized drift compression experiment (NDCX-I) continues to improve longitudinal compression of intense neutralized ion beams

**Shorter pulses (2.4 ns) obtained with new Ferro-electric plasma source**

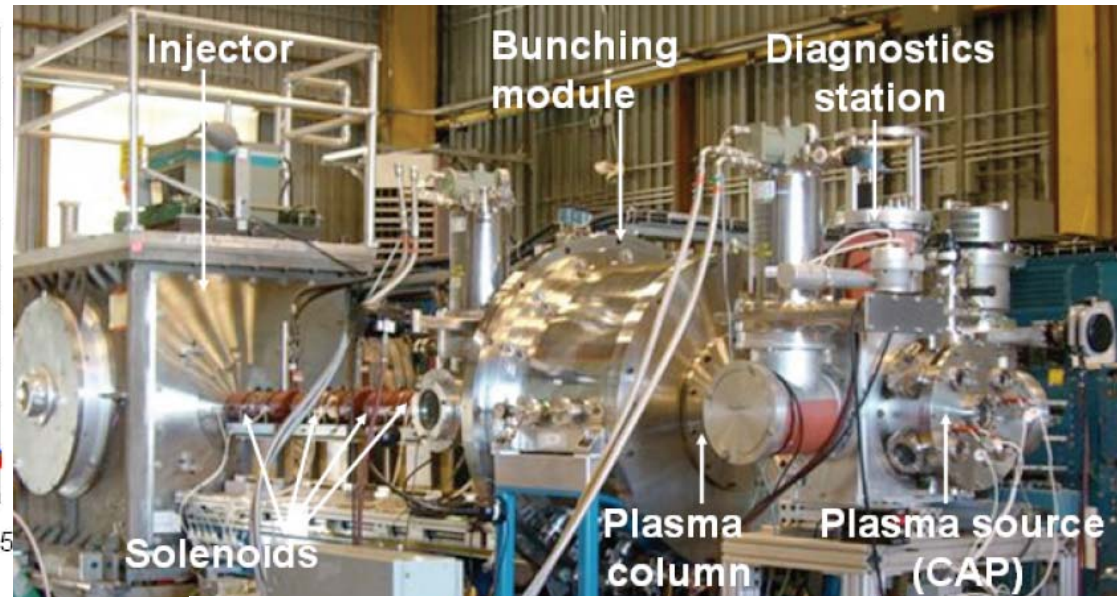
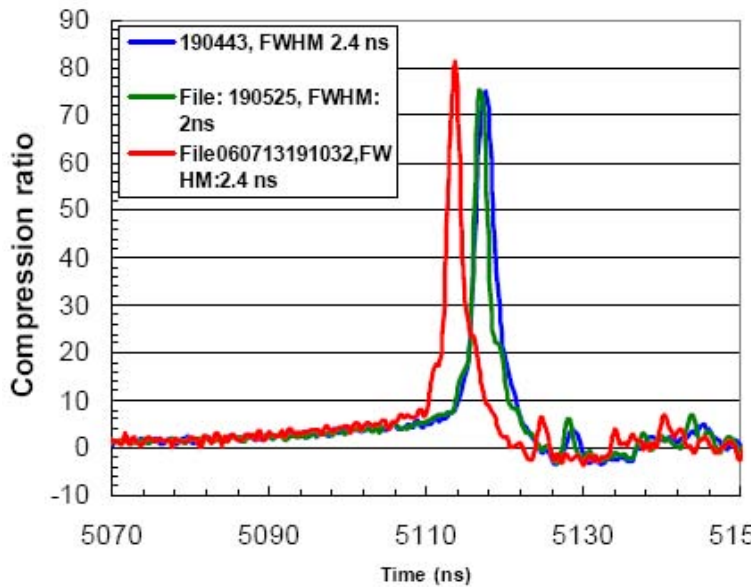

**Simulations predict higher compression with new induction bunching module to be installed later this year**

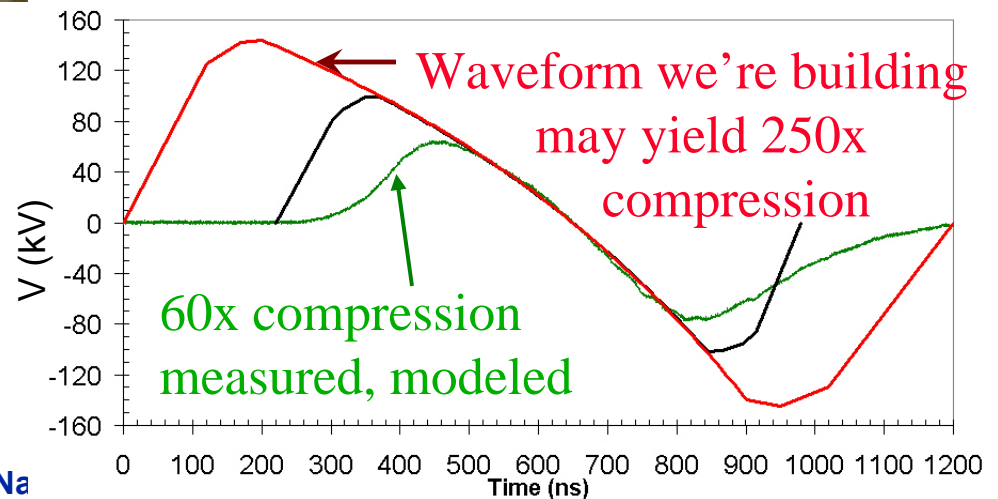
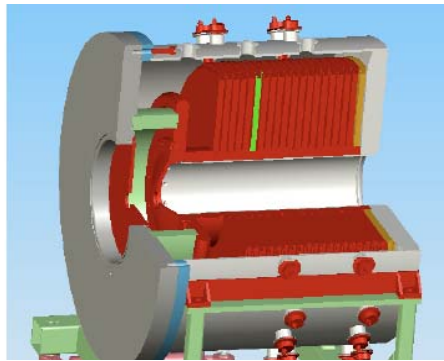

# EXPERIMENTAL TARGET CHAMBER FACILITY FOR NDCX-1A INCLUDING DIAGNOSTICS NEEDED FOR FIRST TARGET MEASUREMENTS

M. LEITNER, F. BIENIOSEK, G. HANSEN, J.-Y. JUNG and P. NI

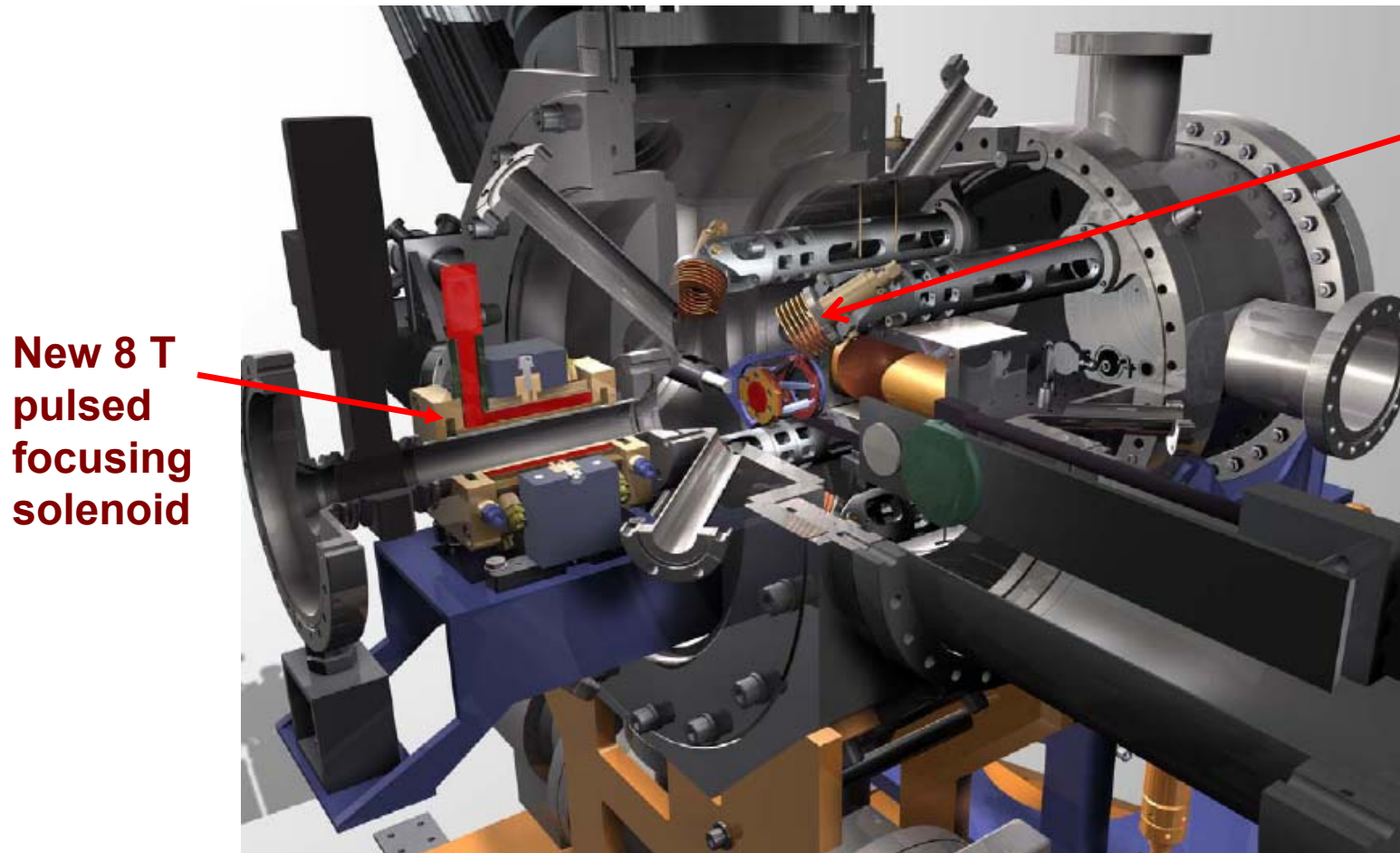

New 8 T  
pulsed  
focusing  
solenoid

Four FCAP  
sources give  
> 20 X more  
plasma  
density near  
the focus!

Sept 15 2007

# Simulations (Adam Sefkow, PPPL→SNL) show smaller NDCX-I focal spots will be possible with a higher field 8T focusing solenoid

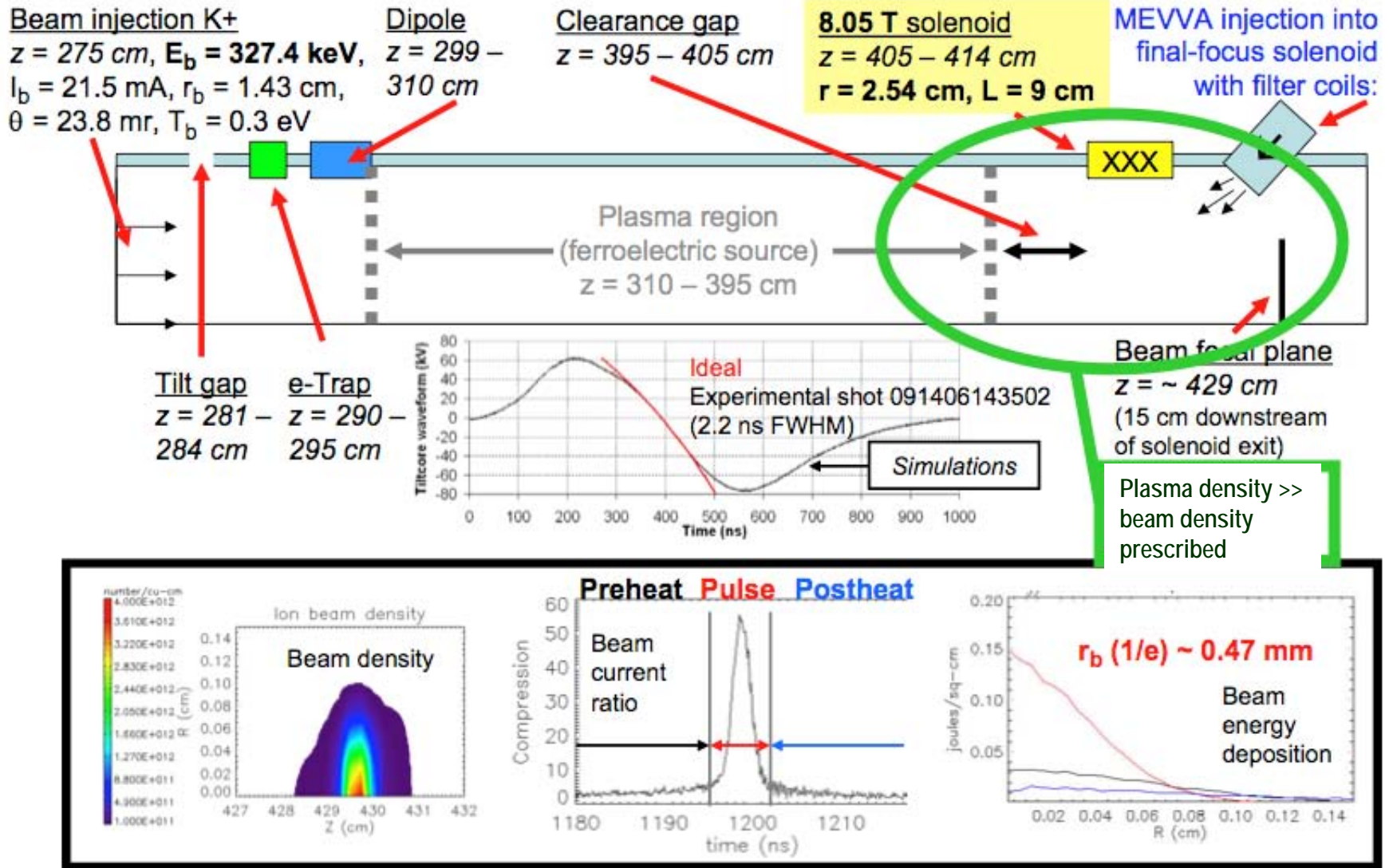



We are developing diagnostics and two-phase EOS models in joint experiments with GSI for isochoric heating & expansion relevant to indirect drive HIF target radiators, and to droplet formation.

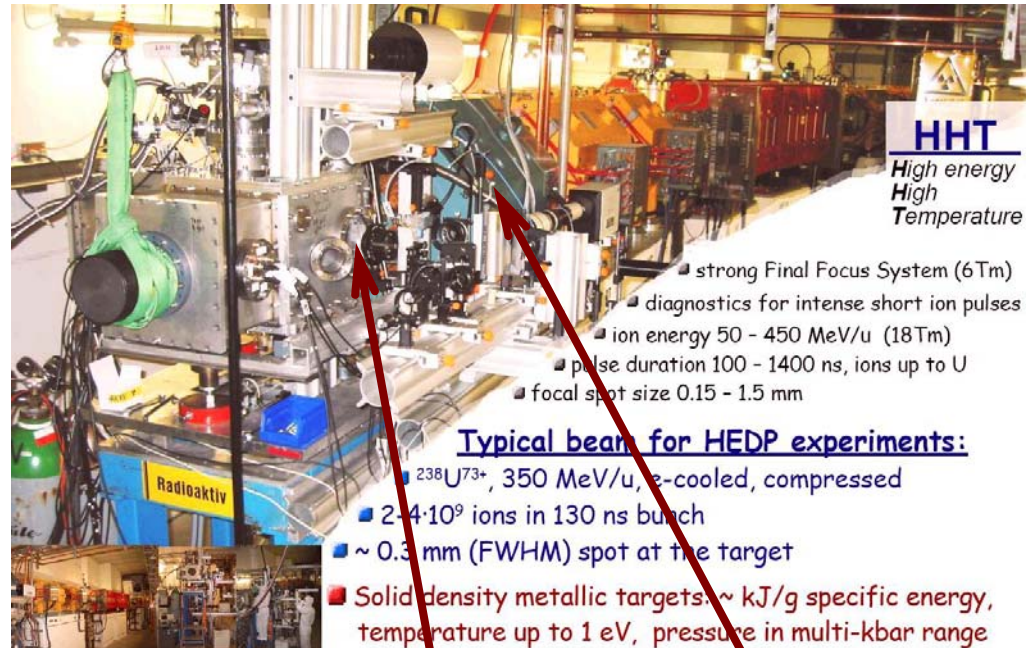
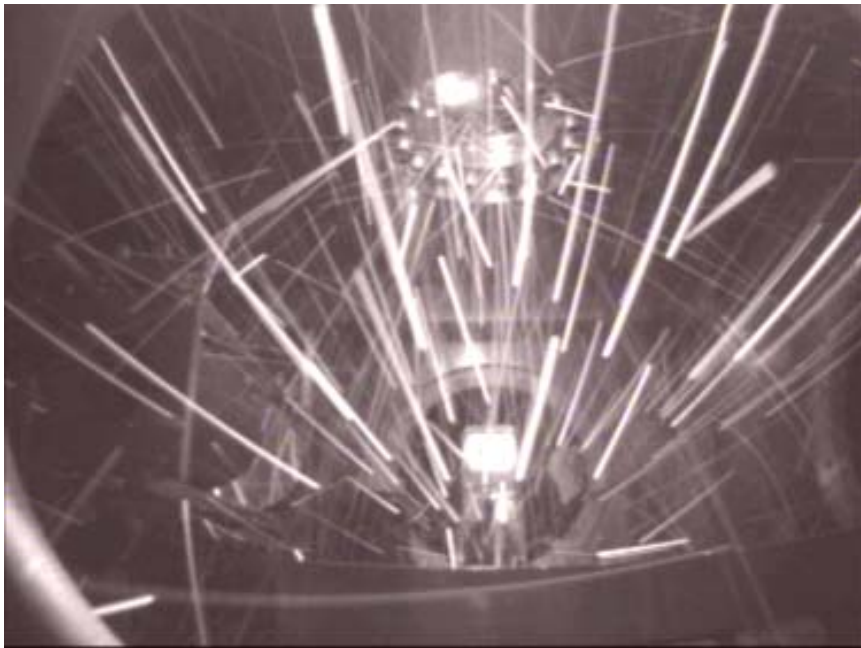

**HHT**  
High energy  
High  
Temperature

- strong Final Focus System (6Tm)
- diagnostics for intense short ion pulses
- ion energy 50 - 450 MeV/u (18Tm)
- pulse duration 100 - 1400 ns, ions up to U
- focal spot size 0.15 - 1.5 mm

**Typical beam for HEDP experiments:**

- $^{238}\text{U}^{73+}$ , 350 MeV/u, e-cooled, compressed
- $2-4 \cdot 10^9$  ions in 130 ns bunch
- $\sim 0.3$  mm (FWHM) spot at the target
- Solid density metallic targets:  $\sim$  kJ/g specific energy, temperature up to 1 eV, pressure in multi-kbar range

**Final focus magnets**

Visible ms camera frame showing hot target debris droplets flying from a VNL gold target (~ few mg mass) isochorically heated by a 100 ns, 100 J heavy ion beam to  $10^{12}$  W/cm<sup>2</sup> and 1 eV in joint experiments at GSI, Germany.

**Measuring two-phase WDM EOS and expansion of target materials @ 1 eV can benchmark/improve models → science that is also relevant to isochoric neutron heating effects in NIF high yield shots.**



# Formation of droplets during expansion of foil is being investigated

Example of evolution of foil in  $\rho$  and  $T$

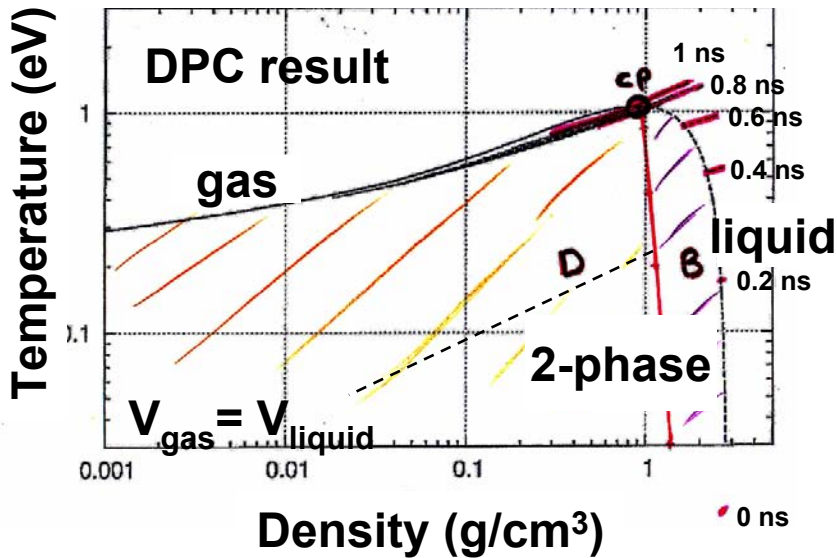

Foil is first entirely liquid then enters two phase regime.

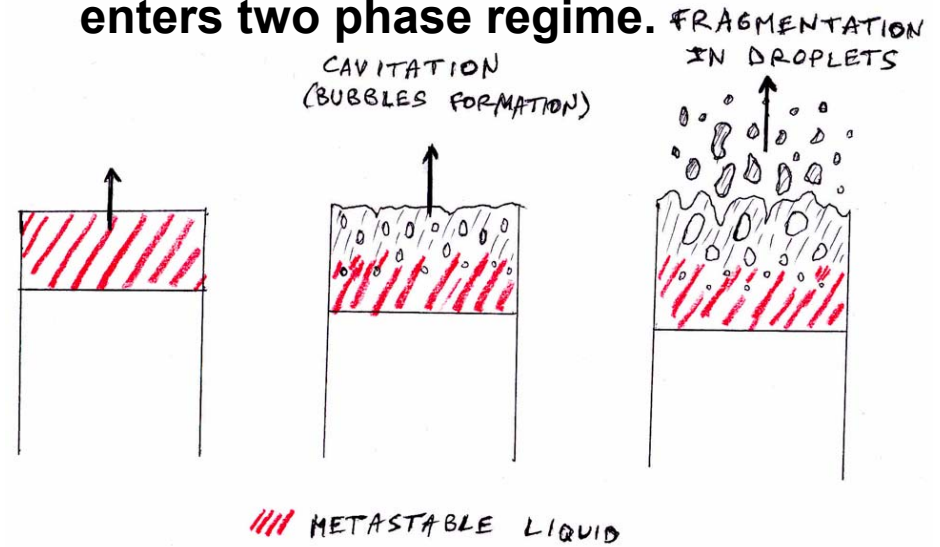

Ref: J. Armijo, master's internship report, ENS, Paris, 2006.

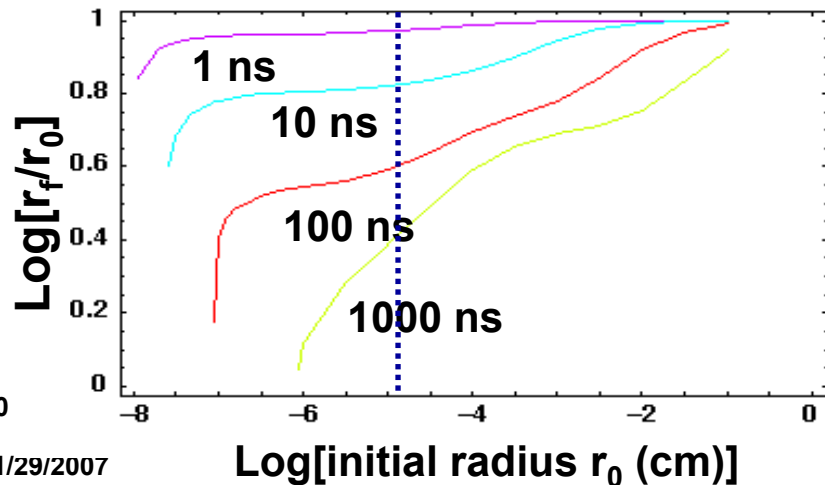

Evolution of droplet radius, (Armijo et al, APS DPP 2006, and in prep).

C. Debonnel and A. Zeballos are incorporating a model for surface effects into hydrodynamics code **Tsunami**

# NDCX Infrastructure

## New target chamber

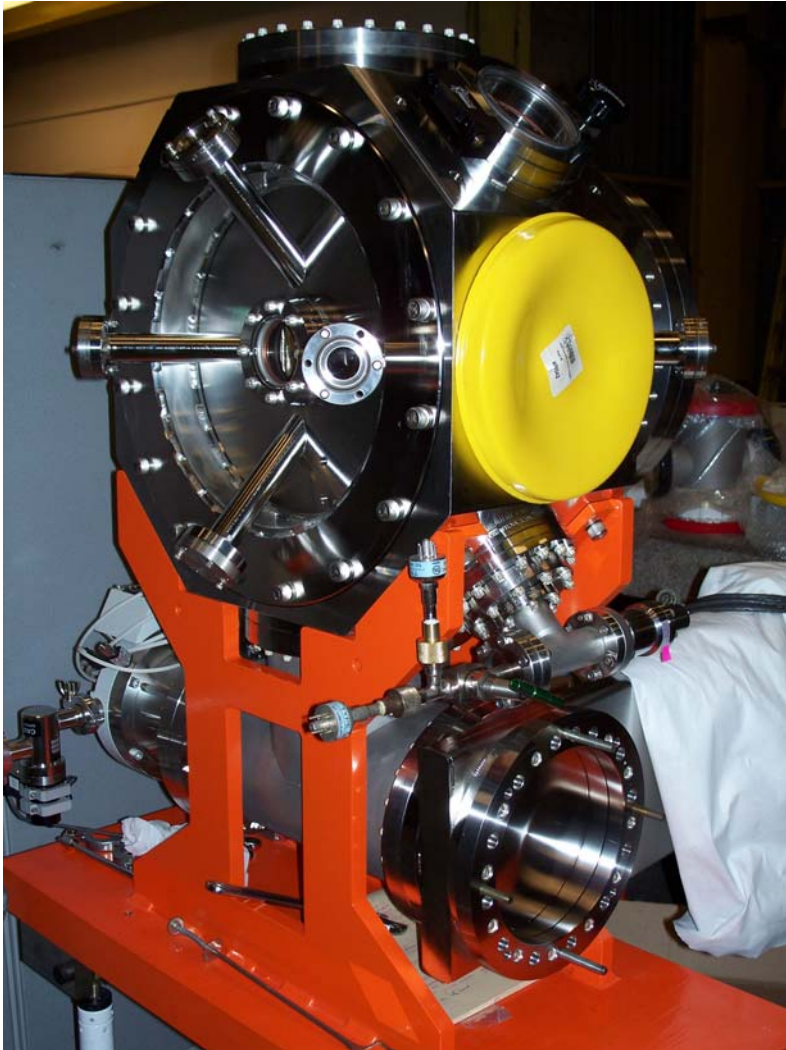

## New optical diagnostics (“laser”) lab



# The HIFS-VNL now has sufficient ATA parts on site to build NDCX-II, enabling direct-drive coupling efficiency experiments

Thanks to LLNL Beam Research Program, we have enough parts for 6 MeV of acceleration. Our main cost item would be to replace solenoids to 1.5 to 2 T (6 m x 100K/m ~ \$600K)

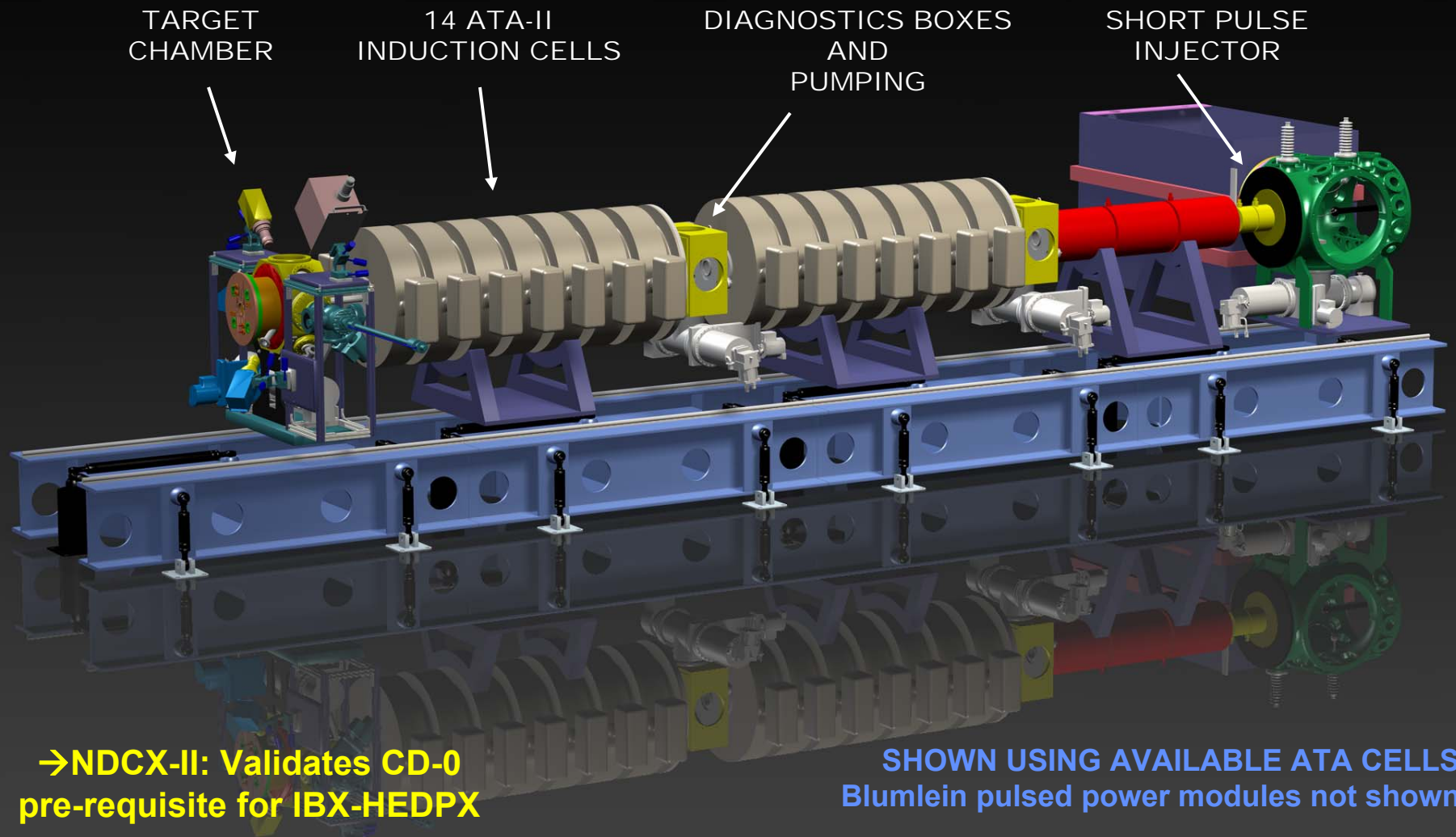

# Double-pulse or ramped-pulse planar target interaction experiments should reveal *unique* heavy-ion direct-drive coupling physics

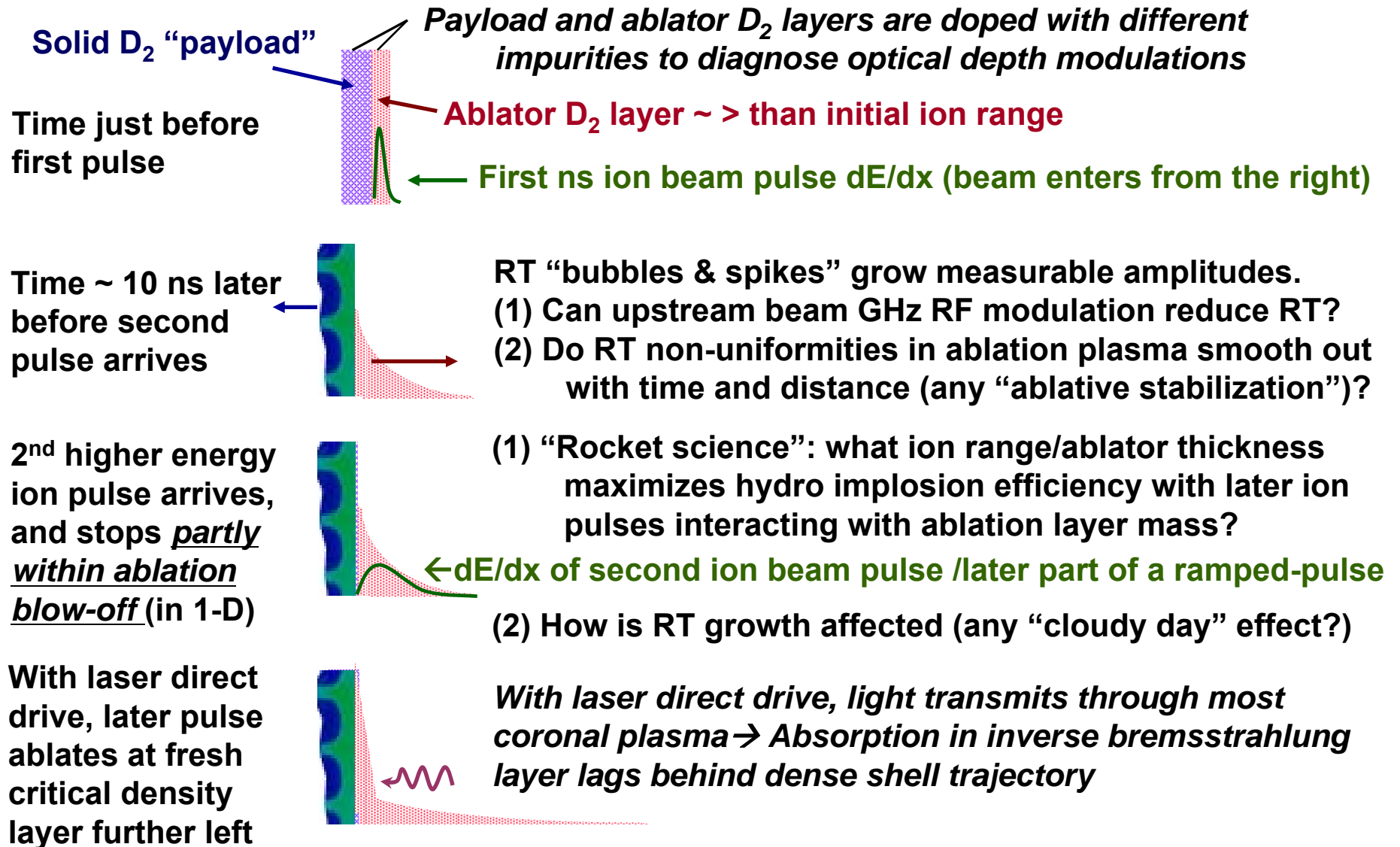

# Proposed schedules for NDCX-I and NDCX-II in the updated HIFS-VNL Five Year Plan for FY09-FY13

## NDCX-1

- (1) TARGET CHAMBER COMPLETE
- (2) INITIAL TARGET EXPERIMENTS
- (3) TIME DEPENDENT FOCUSING
- (4) IMPROVED PLASMA SOURCE
- (5) HYDRO EXPANSION AND TARGET TEMPERATURE MEASUREMENTS

## NDCX-2

- (1) DESIGN
- (2) INJECTOR
- (3) SUPPORT FRAMES
- (4) ACCELERATOR
- (5) DRIFT COMPRESSION
- (6) TARGET CHAMBER

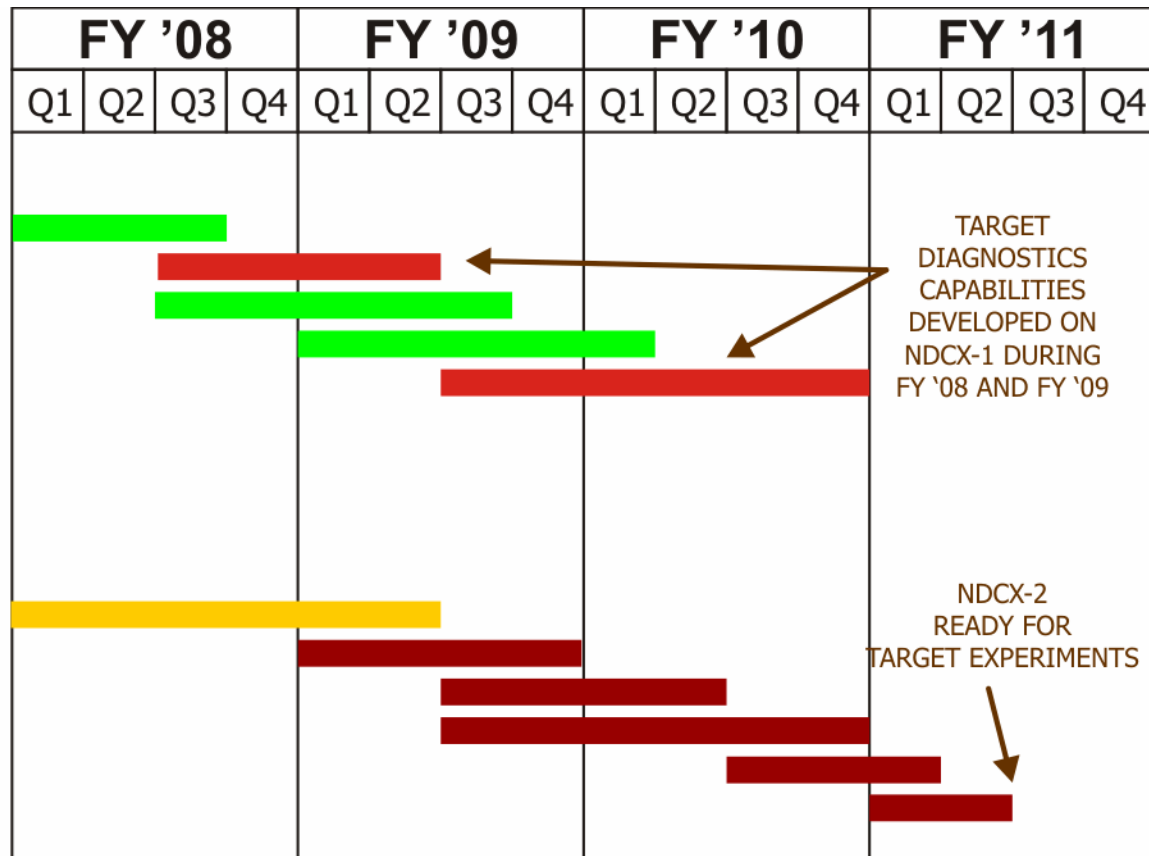

Hardware mods/assembly cost \$4.7M= \$1.7M (09) + \$2.5M (10) + 0.5M (11)

# S. Kawata (Utsunomiya U.) has proposed several techniques to reduce RT growth in ion-beam-driven direct drive

HIB axis rotation or swing  
 -> reduce the R-T growth!

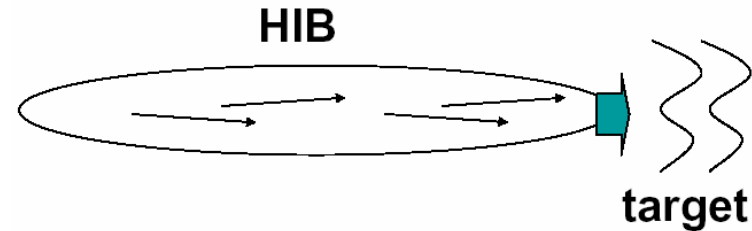

Successive HIBs induce a dynamically Oscillating  $g$ !  
 -> reduce the R-T growth!

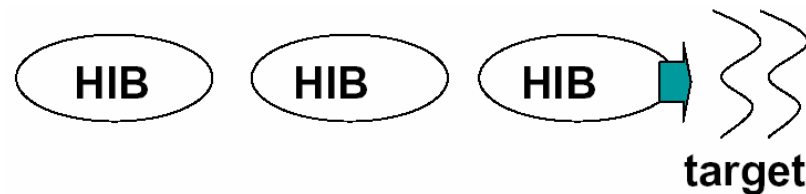

Large-scale HIB-energy deposition profile  
 -> Large-scale density gradient  
 -> Reduce the R-T growth!

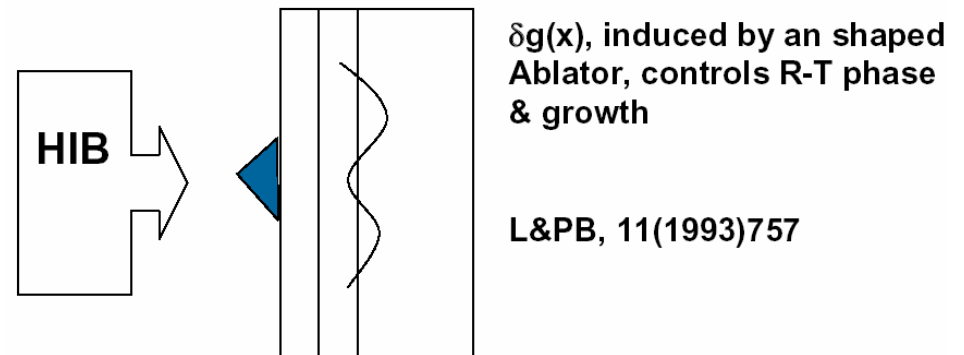

L&PB, 11(1993)757

Shaped target with an Ablator for R-T phase control

**→ These techniques can be explored on NDCX-II or IB-HEDPX**

We have used the LLNL HYDRA code to show how unique heavy ion direct drive hydrodynamics as well as WDM can be studied on NDCX-II

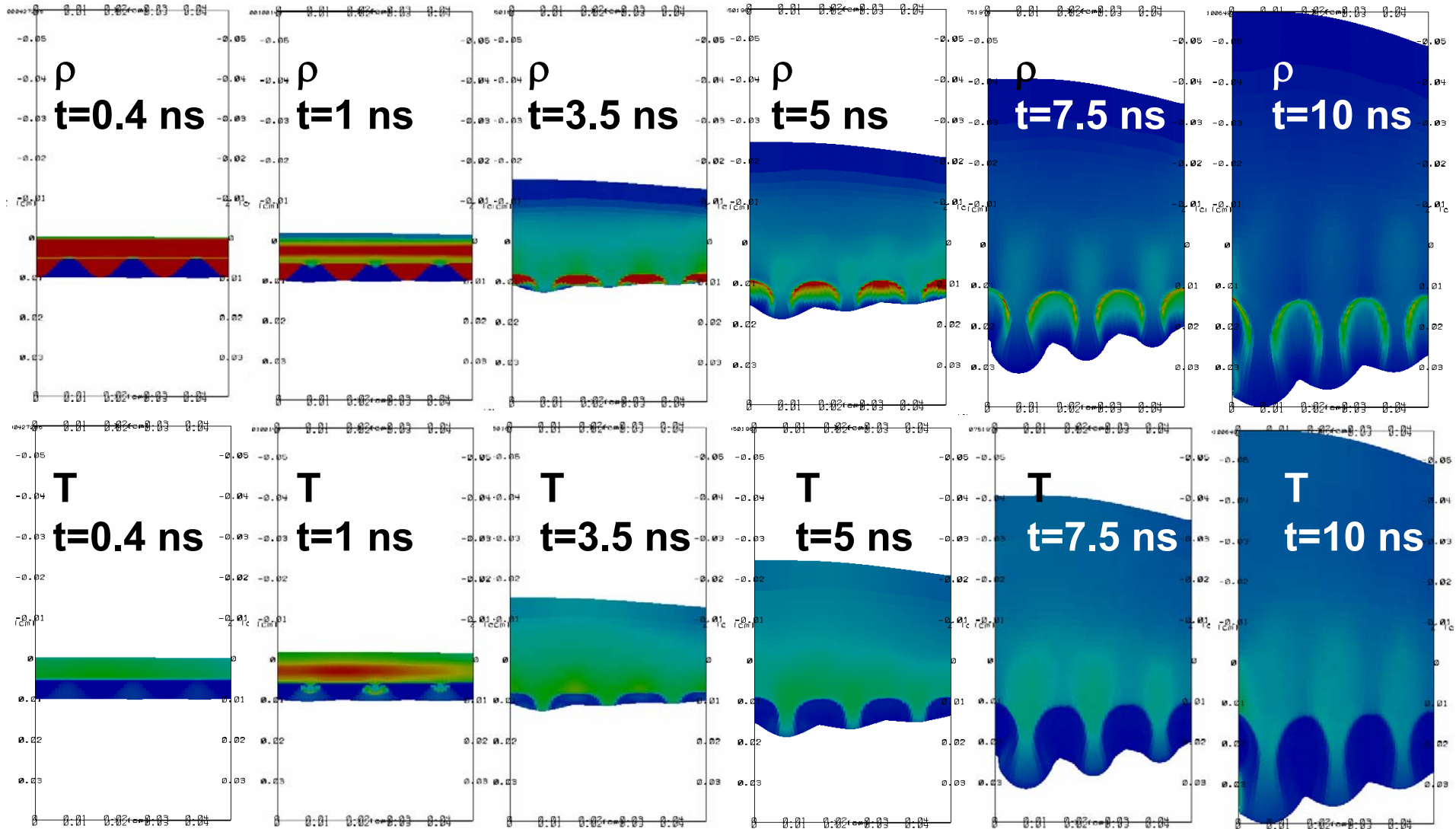

Can modulated beams stabilize ion Rayleigh-Taylor modes? (S. Kawata)



# Our GSI/ITEP collaborators are developing the tools we would need to test dynamic stabilization of ion direct drive RT instability

ITEP design of RF HIB  
GHz Wobbler for GSI

(Much lower RF fields are required to modulate 100 MeV Ar beams compared to 200 GeV Uranium beams!)

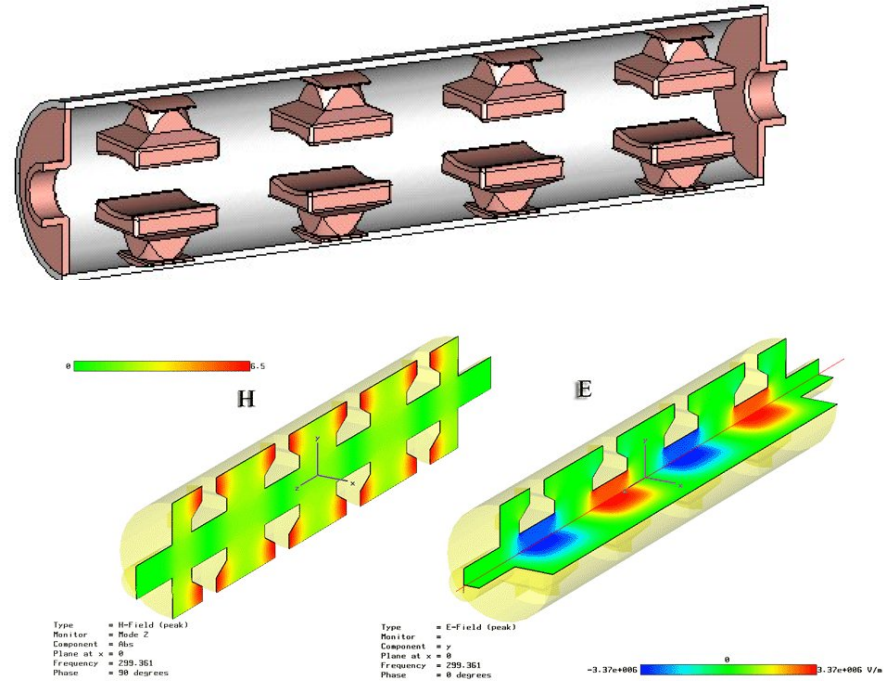

*Beam spot rotation improves symmetry for direct drive: fewer beams needed for azimuthal symmetry*

**Transverse beam intensity distributions @ the focal plane with a single rotating beam!**

→ Two sided (polar) direct drive implosion studies may be possible with two twirled ion beams from two linacs, each with 10-pulse picket fences

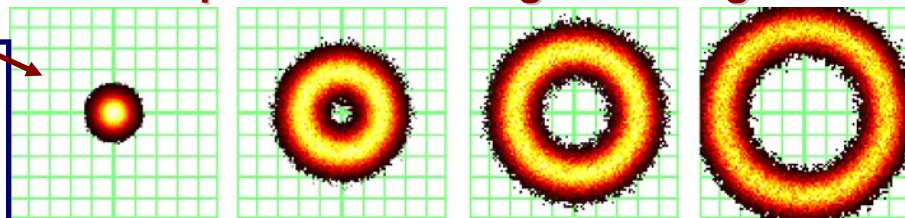

# RF wobblers: rapid beam rotation about a polar axis:

---

- More natural approach to two-sided polar drive geometry most compatible with preferred long-lasting liquid-wall chambers
- With sufficient rotation frequency, possible improved drive symmetry and smoothness with much fewer beams compared to designs with fixed beam pointing- simpler driver-chamber interface.
- Fast RF beam deflection wobblers designed for beam rotation can *also* incorporate control to “zoom” the beam radius off axis during the implosion to improve beam target coupling efficiency.
- Fast beam rotation might reduce Rayleigh Taylor instability growth.

***We invite our Japanese collaborators to join us with our Russian collaborators to explore these topics with a goal of beam experiments within the next four years.***

***→success may revolutionize HIF target design!***

# **We are exploring heavy-ion-driven direct-drive target physics in the ablative rocket regime enabled by compressing and focusing low-range ions in neutralizing background plasma:**

---

- **Double-pulse target experiments planned for NDCX-II: Coupling efficiency of low range ions in cryogenic H<sub>2</sub> or D<sub>2</sub> ablators, RT instability effects with an upstream beam wobbler.**
- **Analytic and hydro code studies of incident drive beam profiles (intensity and range variations in  $r$  and  $\theta$ ) required to support two-sided polar direct drive experiments in future facilities.**
- **Conceptual heavy-ion fusion reactor studies that could exploit neutralized beam compression and focusing, and polar direct drive.**

Heavy ions with the right range can in principle drive targets at the peak of rocket efficiency like x-rays, but without the energy penalty of conversion to x-rays, and with lower ionization loss using H<sub>2</sub> ablators.

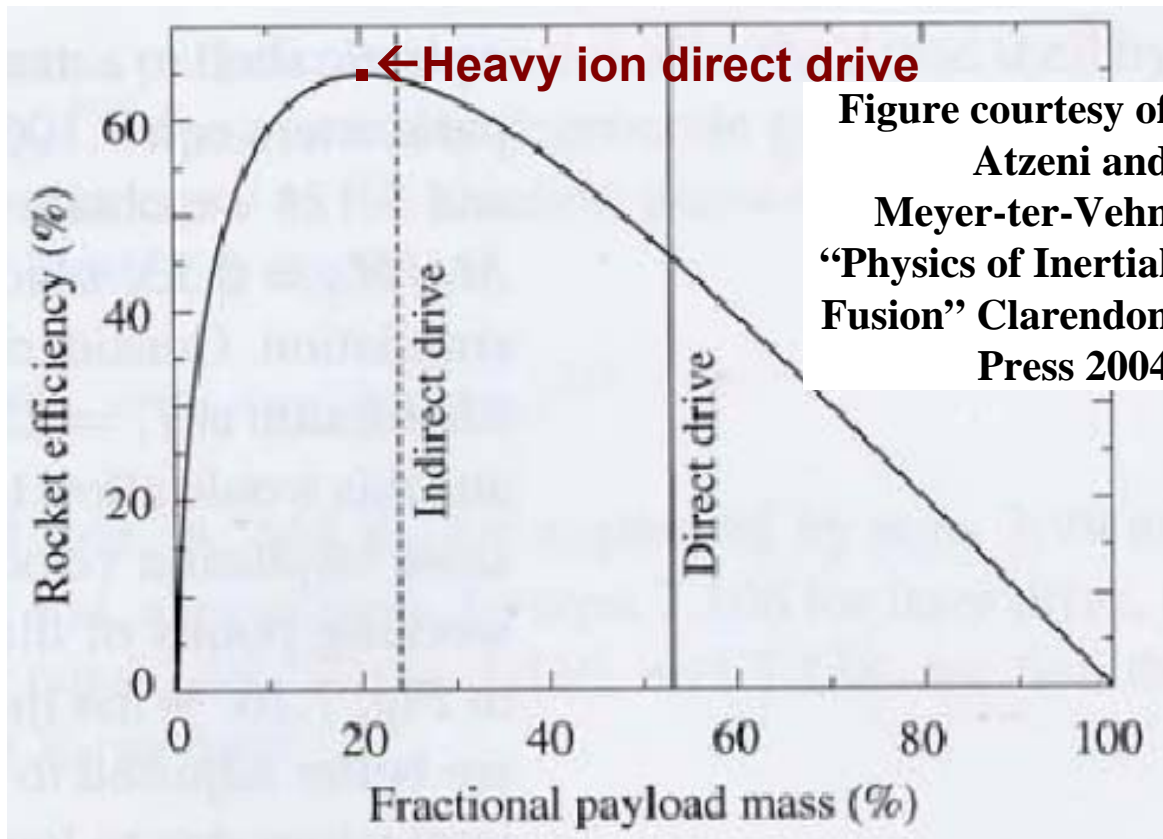
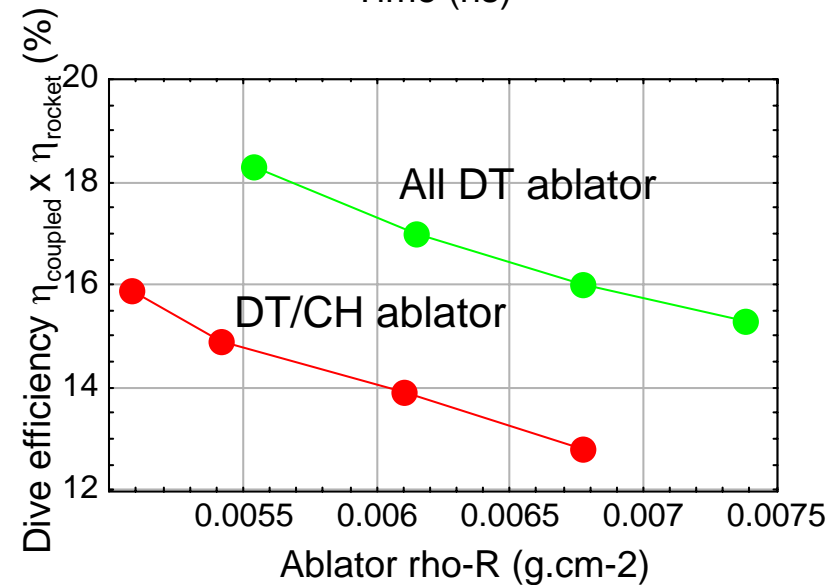
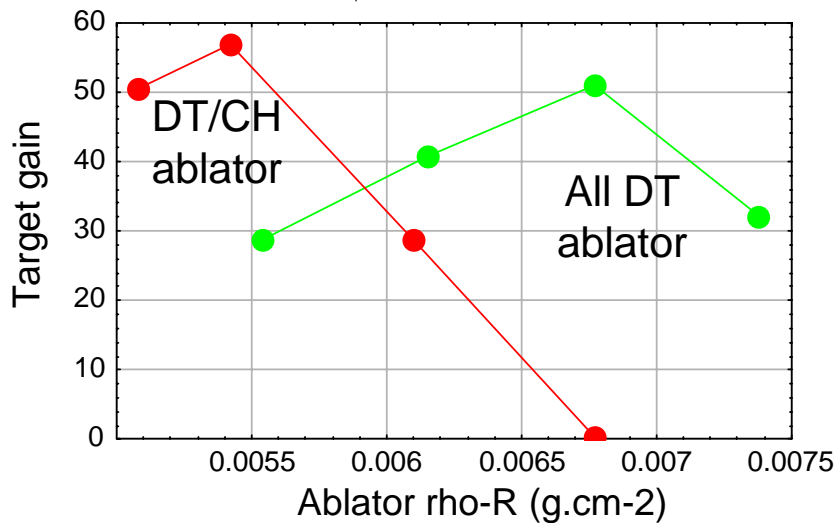
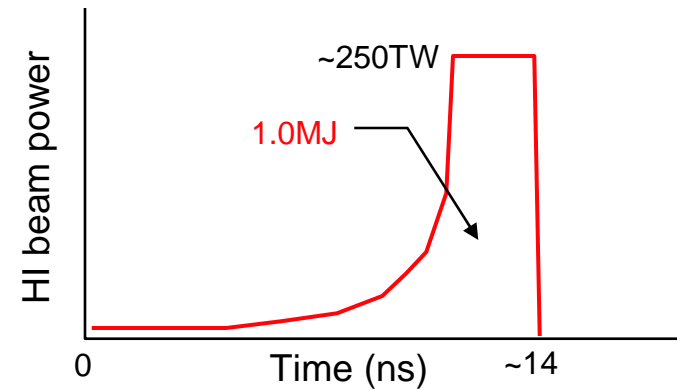
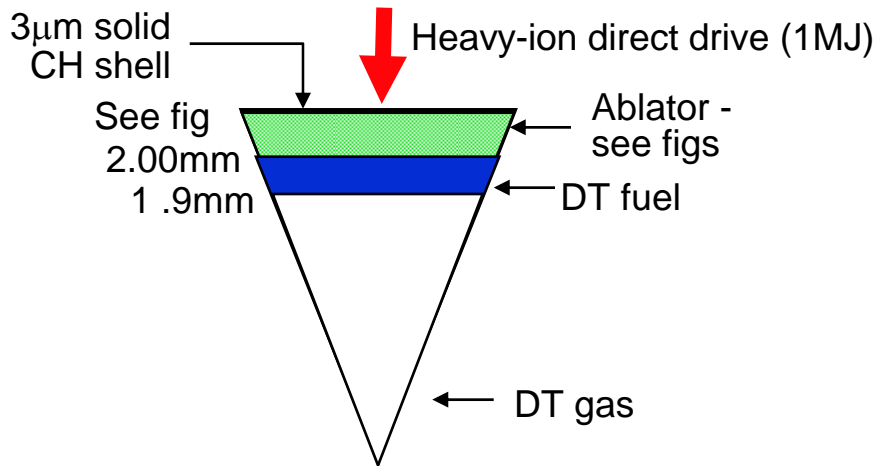

Figure courtesy of Atzeni and Meyer-ter-Vehn "Physics of Inertial Fusion" Clarendon Press 2004

Pure hydrogen ablators for ion direct drive have only 13.6 eV ionization loss  
Beryllium ablators have 180 to 400 eV ionization (three to four electrons ionized)  
Laser coupling is reduced ~ 2 x by electron transport from critical density to ablation front

Heavy ion beams can suffer more parasitic beam losses on out-going ablation corona plasma than either x-ray or laser photons -but our work shows overall coupling efficiencies can still be several times higher.

# First heavy-ion direct drive (no late shock) LASNEX runs by John Perkins (LLNL) suggests gains $\geq 50$ at 1MJ with high drive efficiencies that can be further improved



**Higher drive efficiencies  $\geq 20\%$  may be possible by tuning the ion kinetic energy,  $50 \rightarrow >200\text{MeV}$ , as the capsule implodes**

We are also beginning to use the LLNL HYDRA code in to explore heavy ion direct drive coupling efficiency in 2-D (John Barnard, LLNL)

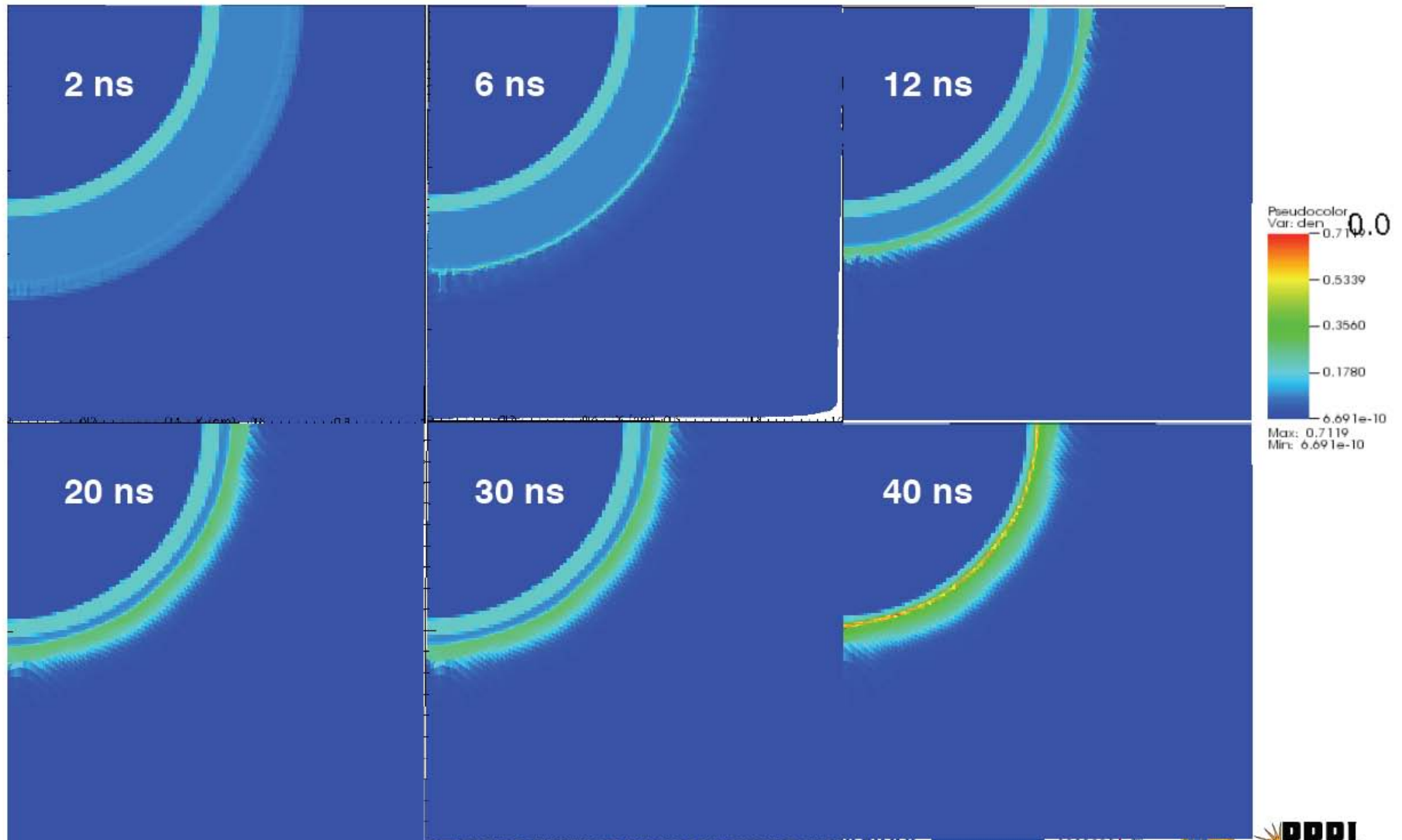

# An IRE-scale new accelerator tool to explore polar direct drive hydro physics with heavy ions in parallel with NIF

Concept: 10 kJ direct drive implosion experiments using two opposing linacs, each with 10 pulses for variable “picket fence” pulse shaping

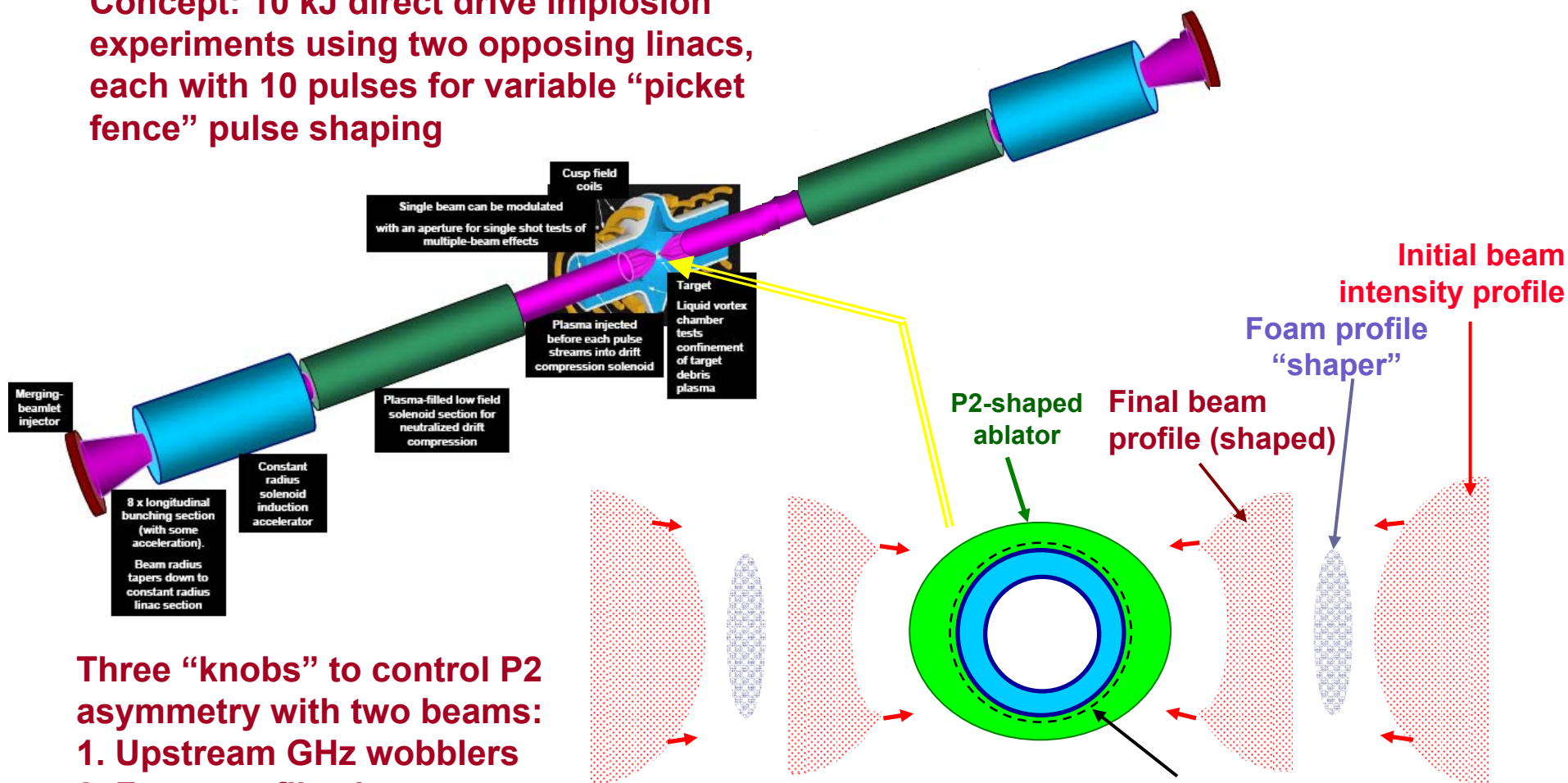

Three “knobs” to control P2 asymmetry with two beams:  
 1. Upstream GHz wobblers  
 2. Foam profile shapers  
 3. Ablator shaping

Goal is implosion drive pressure on the Cryo D<sub>2</sub> payload with < 1 % non-uniformity

# The DARHT 2nd Axis: a state-of-the-art induction accelerator @ >50 kJ/ electron beam pulse. Technology relevant to induction linac

*The DARHT 2nd Axis Project is a collaborative effort among LANL, LBNL, and LLNL*

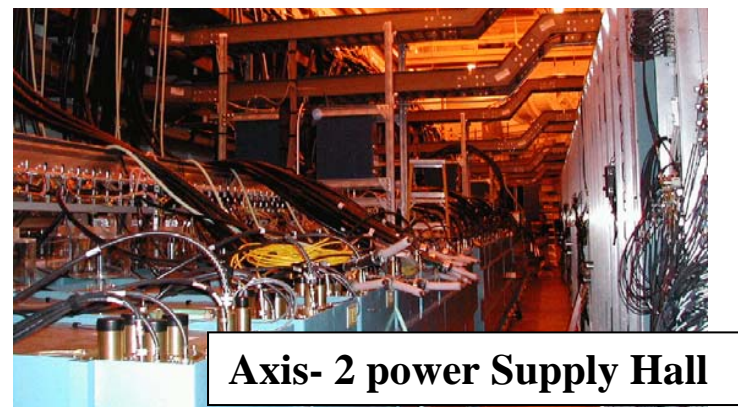
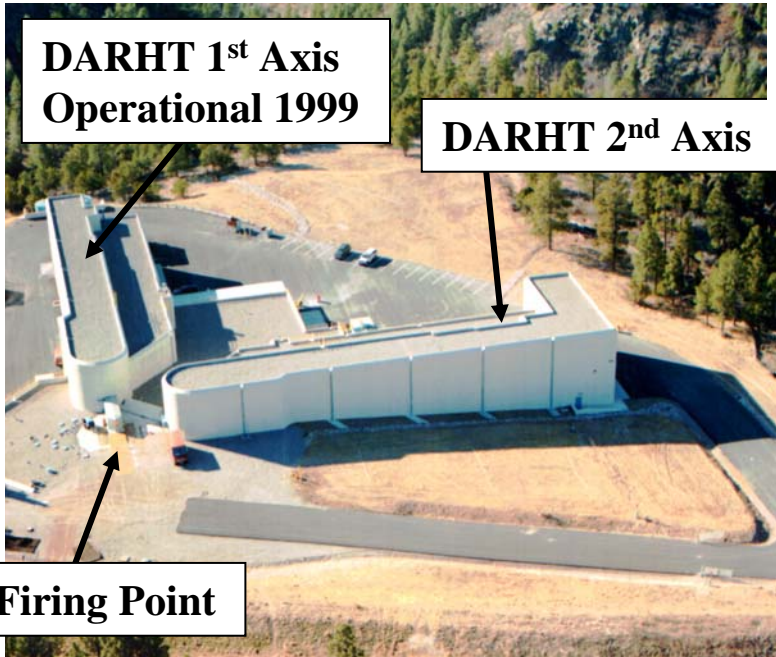



# Heavy ion driven HEDP and fusion: Conclusions

---

- Heavy Ion Fusion Science experiments and simulations on NDCX I are making outstanding progress in neutralized beam compression and focusing in background plasma.
- Warm Dense Matter experiments are beginning
  - Transient darkening experiments on HCX
  - Metallic foam studies at GSI
  - Target heating experiments ( $\sim .2 - .5$  eV) to begin this year on NDCX I
  - 1 eV experiments on NDCX II by 2010
- Hydrodynamics experiments for stability and ion ablative direct drive physics are being studied for NDCX II.
- Analytic and hydro code calculations are being pursued for heavy ion fusion in two-sided polar direct drive geometry.

---

# BACKUP SLIDES



# All ADRHT-II Induction Cells Have Been Refurbished and Tested at LANL, Meeting All Requirements

**200 kV/cell**  
**1.6  $\mu$ s;  $\pm$  0.65%  $\Delta$ V**

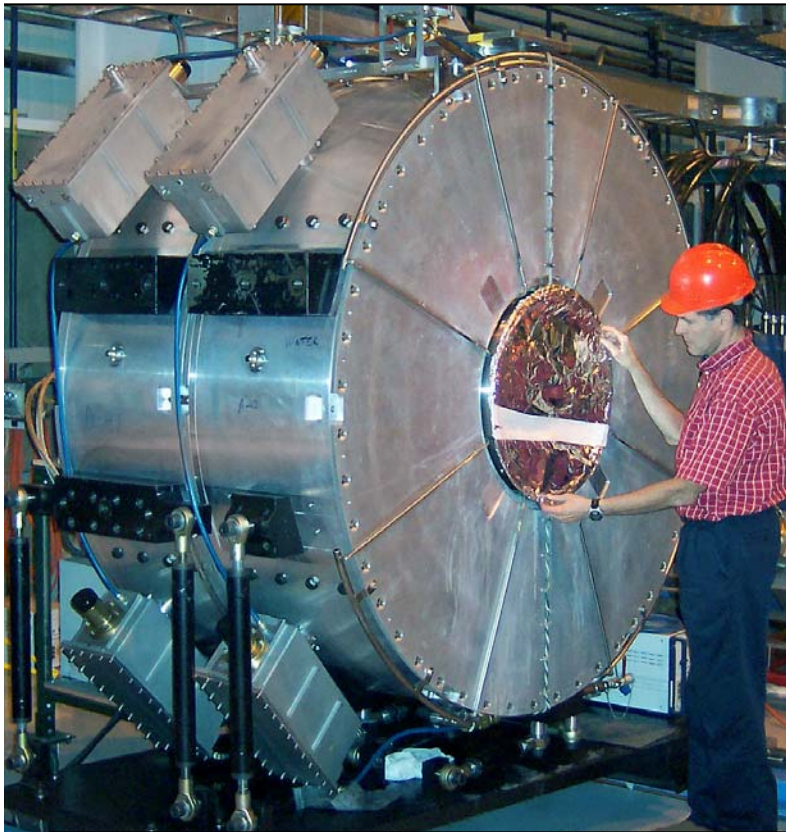

Each cell is 1.85-m in diameter and weighs 7,300 kg

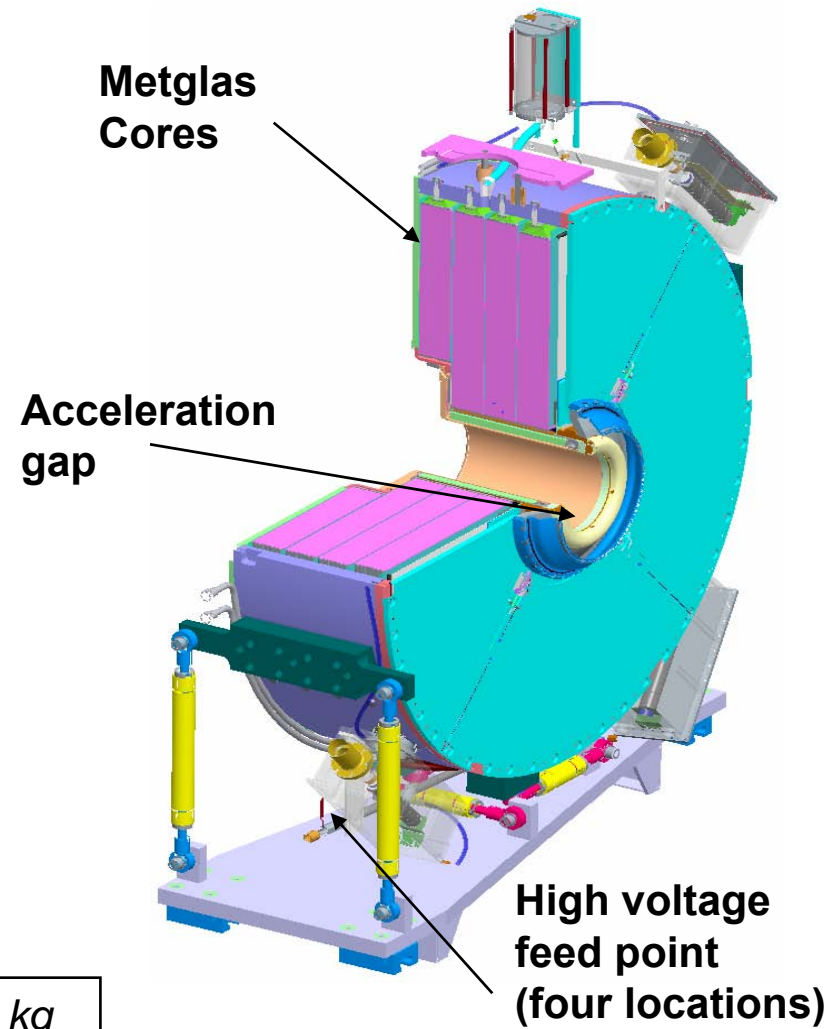

# Streak camera for time resolved spectroscopy of target

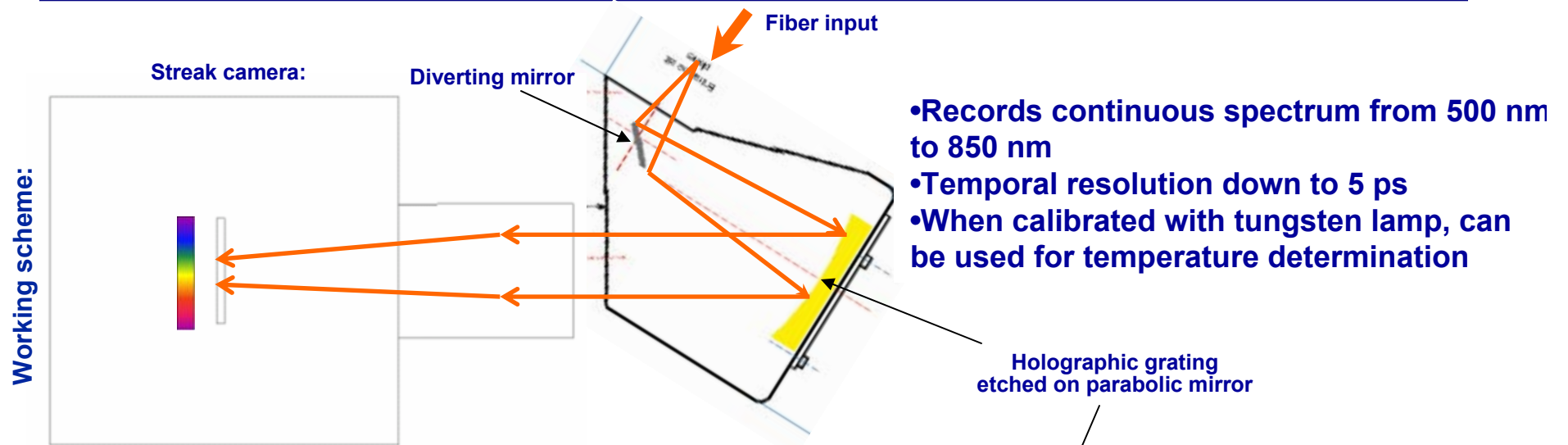

Implementation:

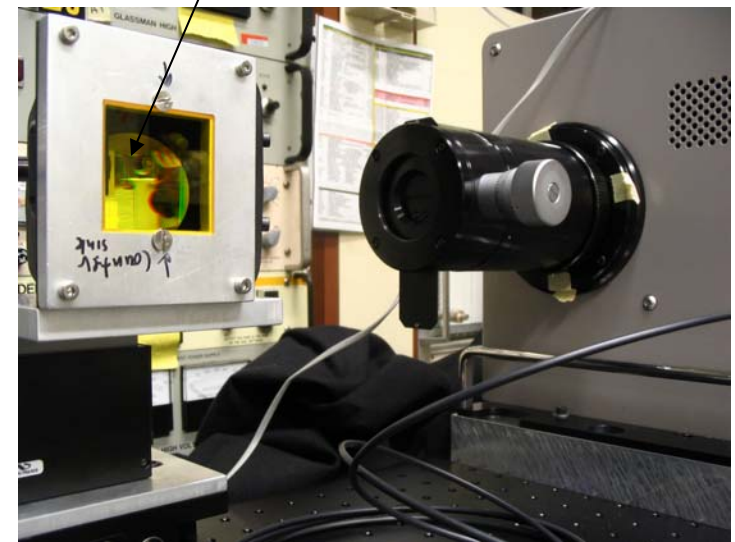
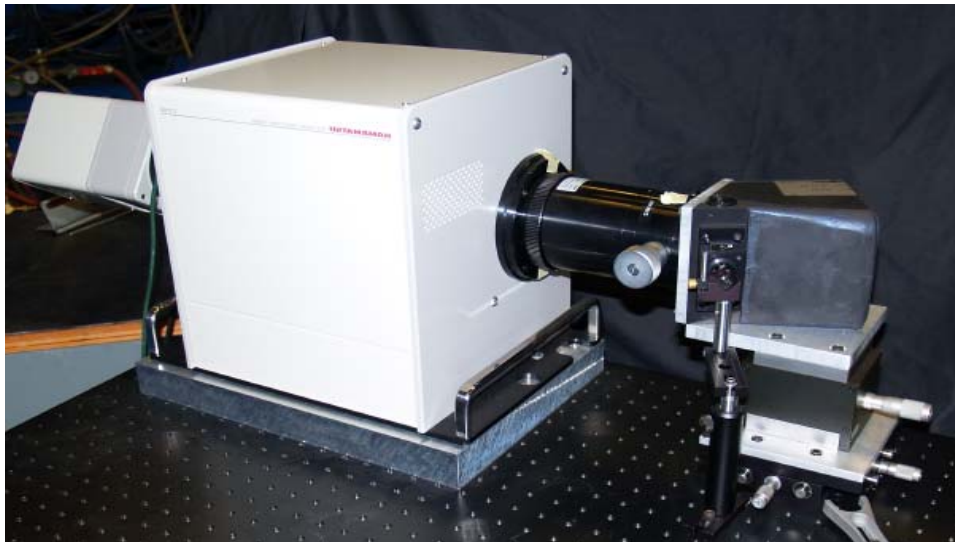

# VISAR for target pressure measurement

Velocity of a piston (6 shots):

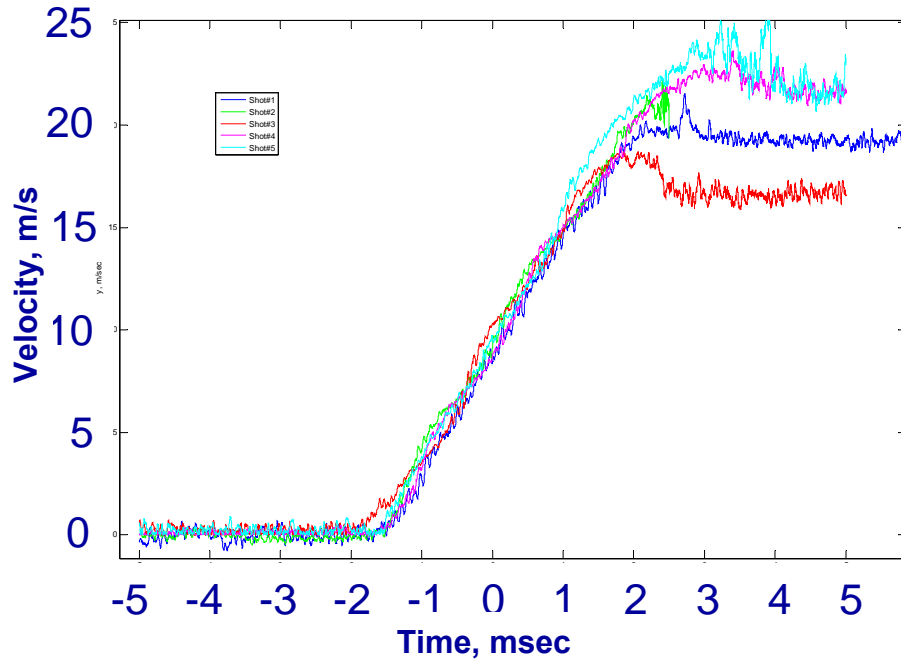

Setup for testing of VISAR:

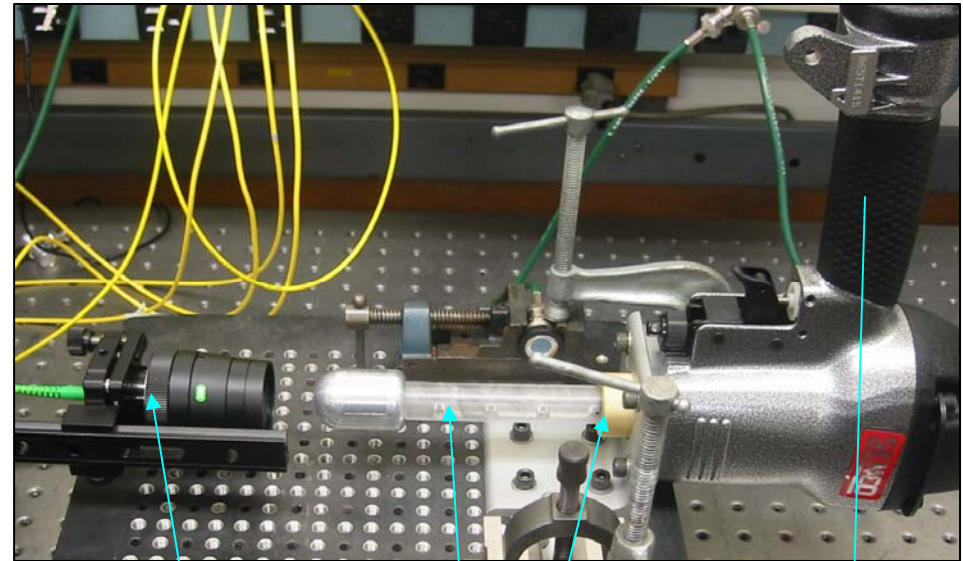

Martin, Froeschner & Associates All Fiber Push-Pull Doppler Velocity Interferometer (VISAR)

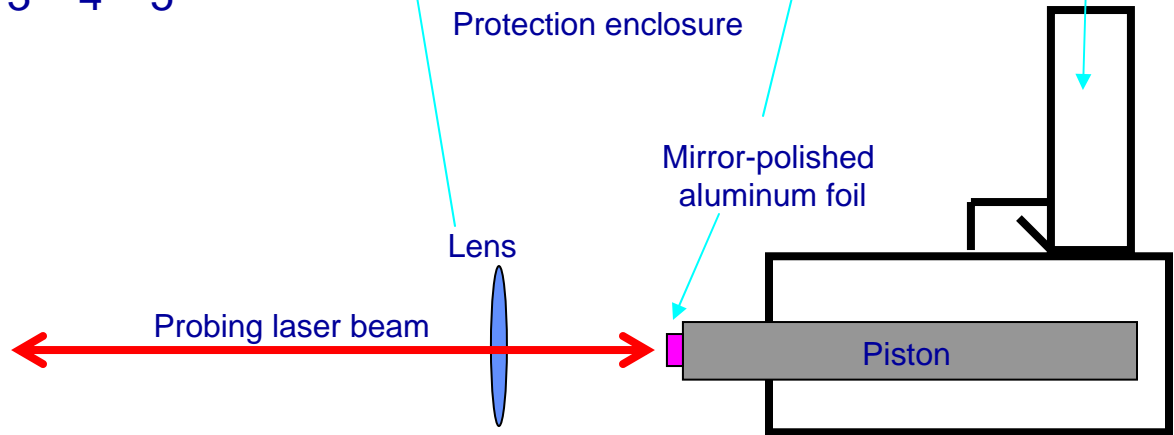
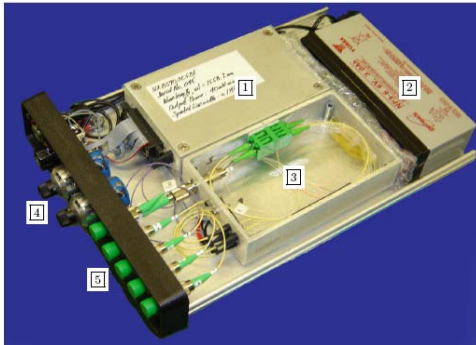

**In June 2007, first tests using a 5 T final focus magnet increased final focus beam intensity on axis -further optimization in progress**

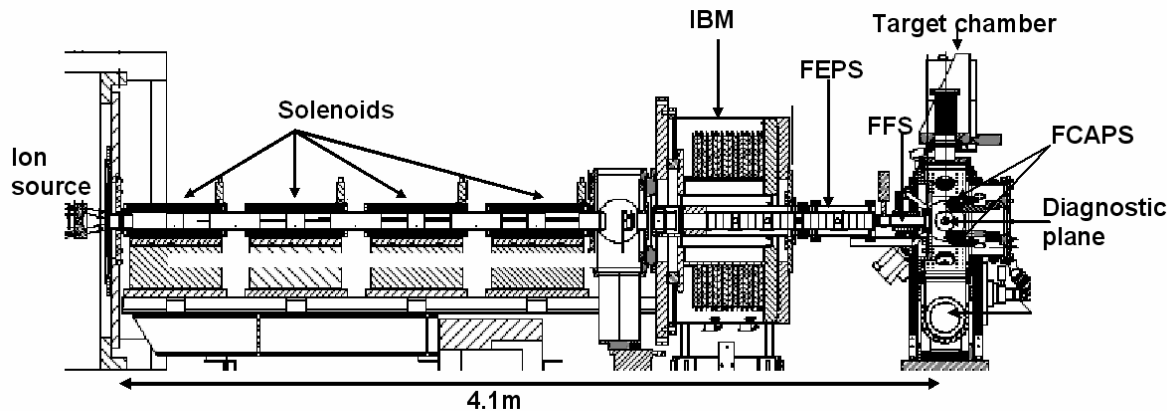

**NDCX Left to right: 315 keV, 25 mA K<sup>+</sup> ion source, solenoid transport section, induction bunching module (IBM) which imparts the velocity ramp on a 150 ns slice of the injected beam, ferroelectric plasma source (FEPS), 5T final focus solenoid (FFS), and new target chamber containing diagnostics at the target plane and two filtered cathodic arc plasma sources (FCAPS).**

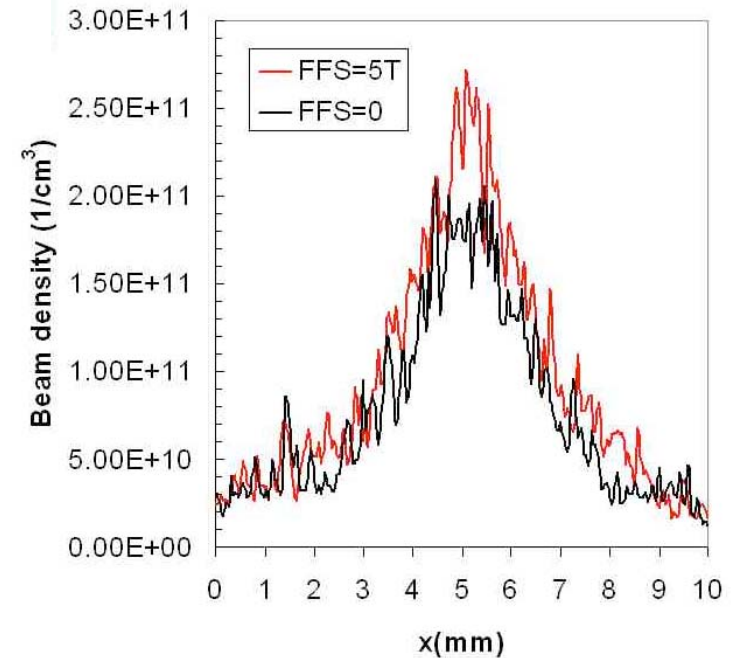

**Beam density profiles at the target focal plane with the final focus solenoid on (FFS=5T) and off (FFS=0).**

# Solenoid transport experiments in 2006: when e-clouds were *not* trapped with biased wall electrodes, measured beam envelopes agreed well with simulations.

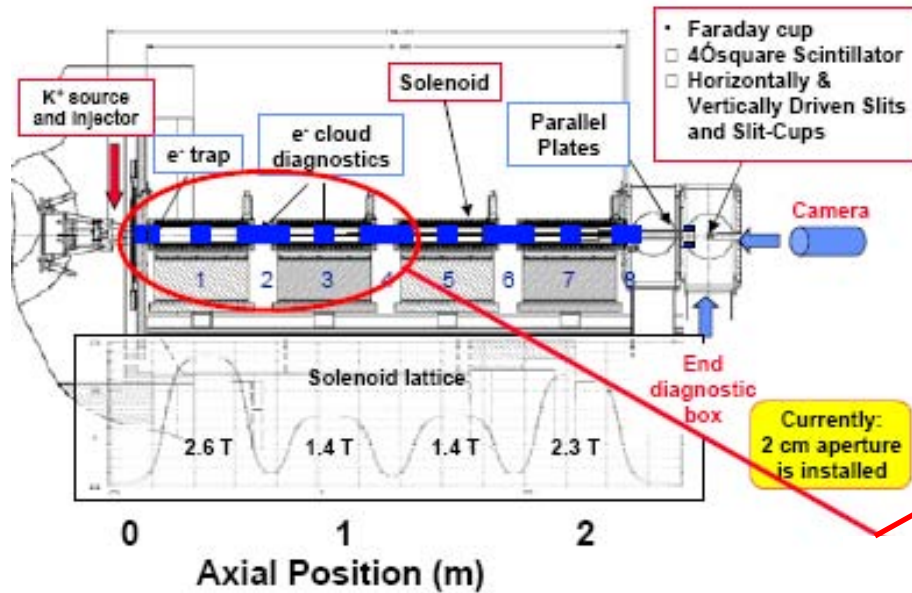

Cylindrical electrodes in solenoid bores used to clear or trap e-clouds

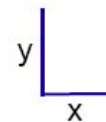
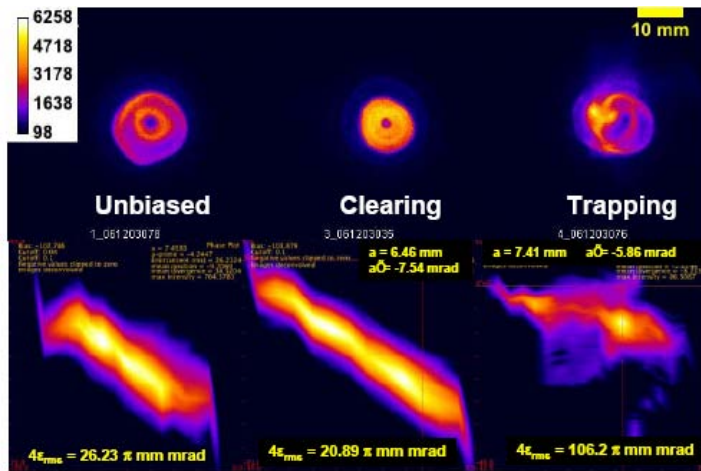
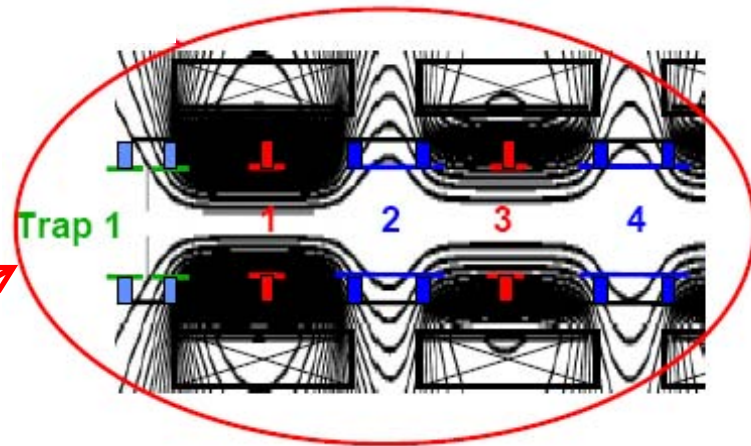

← Transverse X-Y beam images

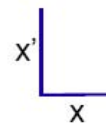

← X-X' phase space beam measurements

# Isochoric heating by ion beams can simulate neutronic isochoric heating near NIF target (Dave Eder, LLNL)

Exposure:  $10^{17} - 10^{19}$  neutrons per shot

$$kT \sim 4 \text{ eV} (1 \text{ cm/r})^2 (N_n/10^{19})(\sigma/10^{-24} \text{ cm}^2)$$

Near target, material is vaporized, but some material a few cm away is volumetrically preheated by neutrons to melting point or lower, changing material properties, before hohraum shock wave reaches preheated material

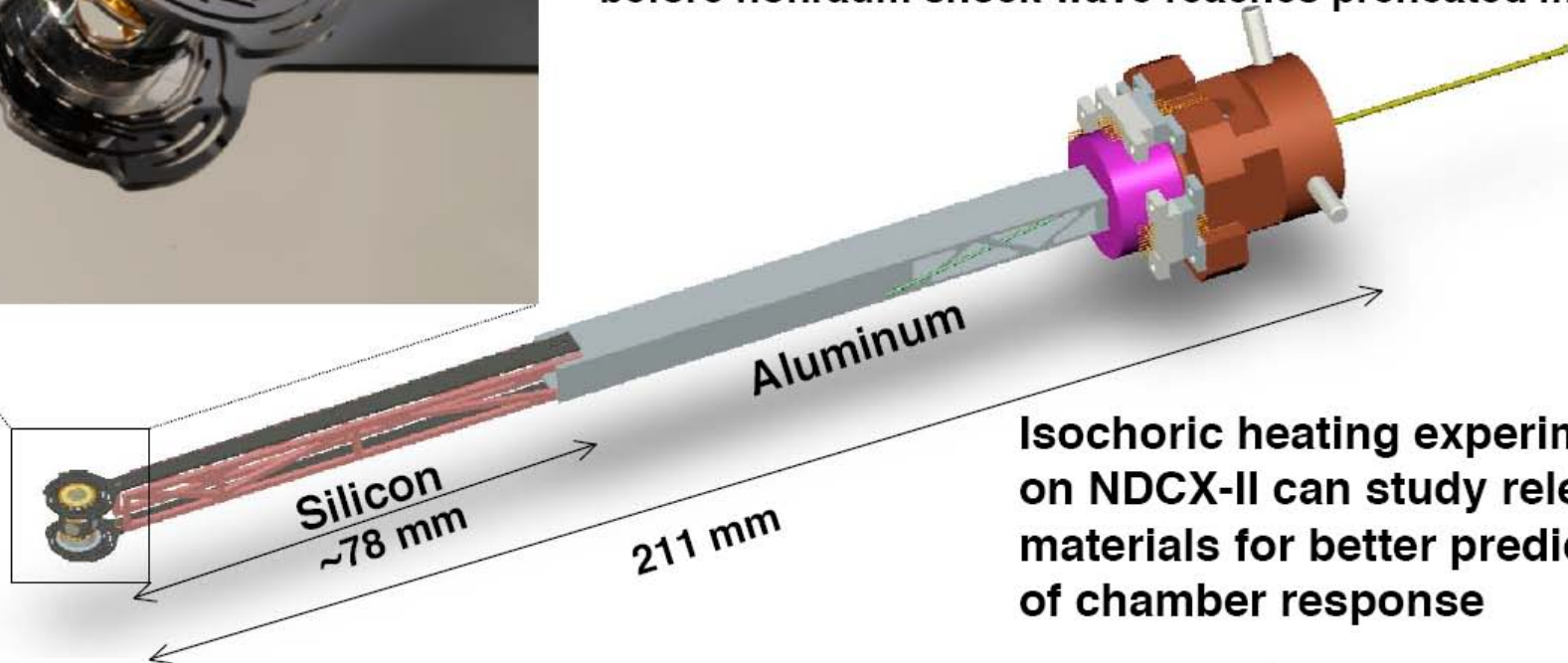

Isochoric heating experiments on NDCX-II can study relevant materials for better predictions of chamber response



# Is it Time to Reconsider Direct Drive for HIF (John Perkins, LLNL)?



**With modern (mainly DT) direct drive capsules, efficient heavy-ion beam coupling and shock ignition, ~1MJ drive may suffice for gains  $\geq 200$  and  $\eta_G > 20$ !**

- Adiabatic shaping and SSD beam smoothing makes direct drive viable for NIF
- LLE/NIF polar-direct-drive will test geometries suitable for liquid protected chambers
- Direct drive capsule radii  $> 2\text{mm}$  allow large beam spots
- Neutralized drift compression allows multiple pulses of lower ion ranges
- Shock ignition direct drive enables high gains/yields without the need for separate PW lasers

**$\Rightarrow$  Pursuit of direct drive and shock ignition allows HIF to take advantage of ongoing progress in modern laser facilities as it had for indirect drive**

# Initial LASNEX results (John Perkins, LLNL) also suggest promise for shock-ignited heavy-ion targets at $\geq 1\text{MJ}$ drive.

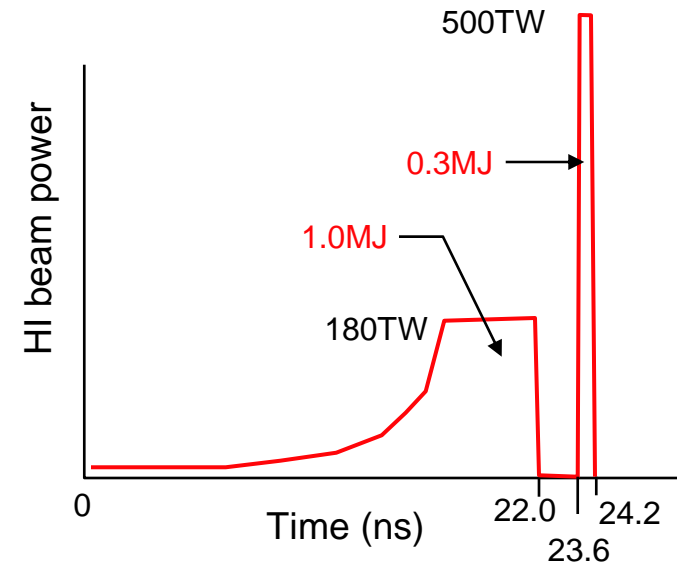
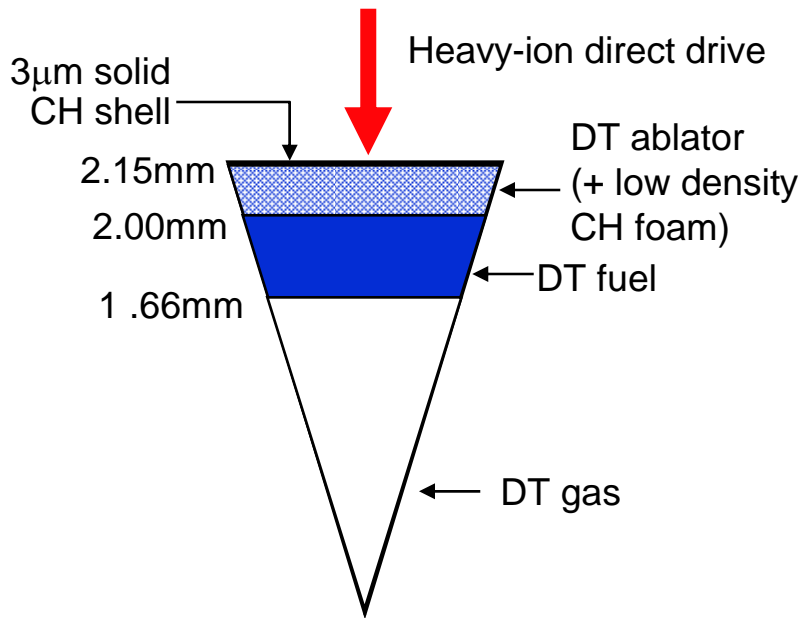

Heavy-ion drive	50MeV Ar ( $z = +8$ accel, +16 drift/focus)
Drive energy	1.0(main) +0.3(shock) = 1.3MJ
Yield	199MJ
Gain	153
Peak velocity	$2.2e7\text{cm/s}$
Drive efficiency ( $\eta_{\text{coupled}} \times \eta_{\text{rocket}}$ )	8.6% (not yet optimized for low velocity fuel assembly)
rho-R	$2.25\text{ g.cm}^{-3}$

# Recent LASNEX work confirms T-lean targets can self breed tritium @ $\rho R_{\text{tot}} \sim 10 \text{ g/cm}^2$ and 500 MJ yields (Kai LaFortune, LLNL)

H. Takase, S. Kawata and K. Niu: , J. Phys. Soc. Jpn., 52 (1983)

Max Tabak, Nuc. Fusion 36, No2 (1996).

Atzeni and Ciampi Nuc. Fusion 37, 1665 (1997)

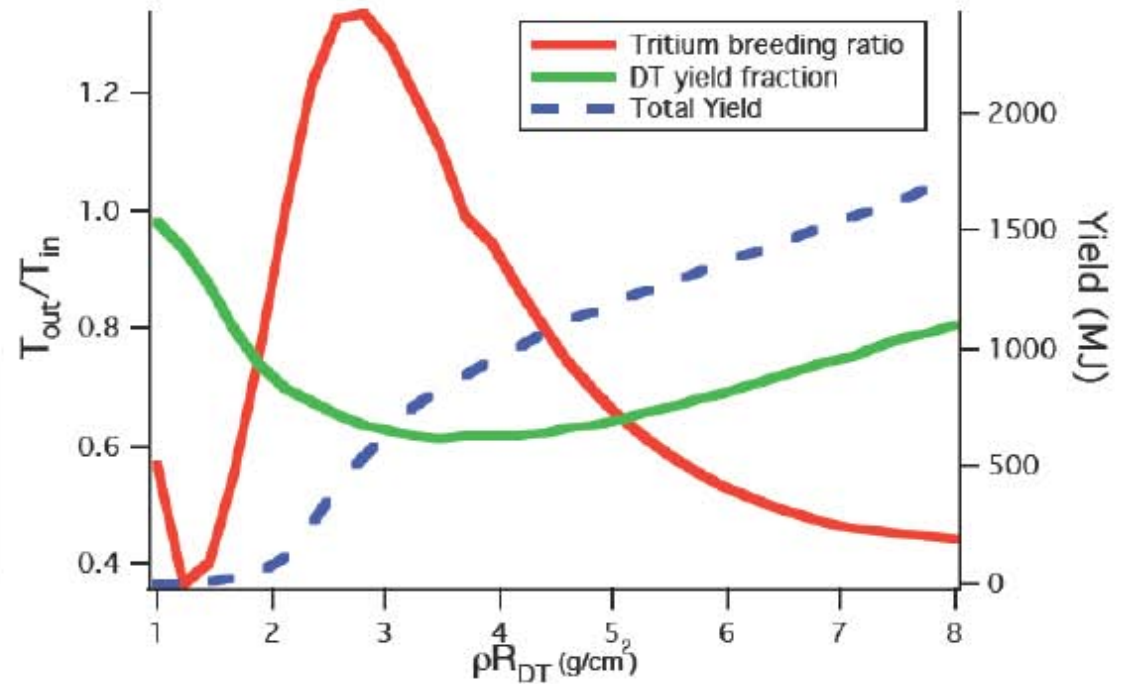
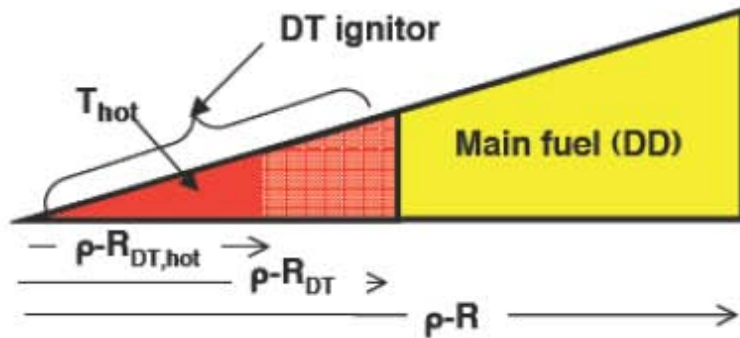

T- breeding ratio, DT yield fraction (mostly from T originating from D(d,p)T reactions of the majority DD fuel), and total fusion yield as a function of the DT core  $\rho R_{\text{DT}}$ .

**→ Required 1 MJ compressed fuel assembly energy → 3.3 MJ (5 MJ) drive energy with heavy-ion direct drive coupling efficiency of 30% (20%).**

# Preliminary results for heavy-ion direct-drive efficiency are very encouraging. Validation with 2-D hydro codes are planned.

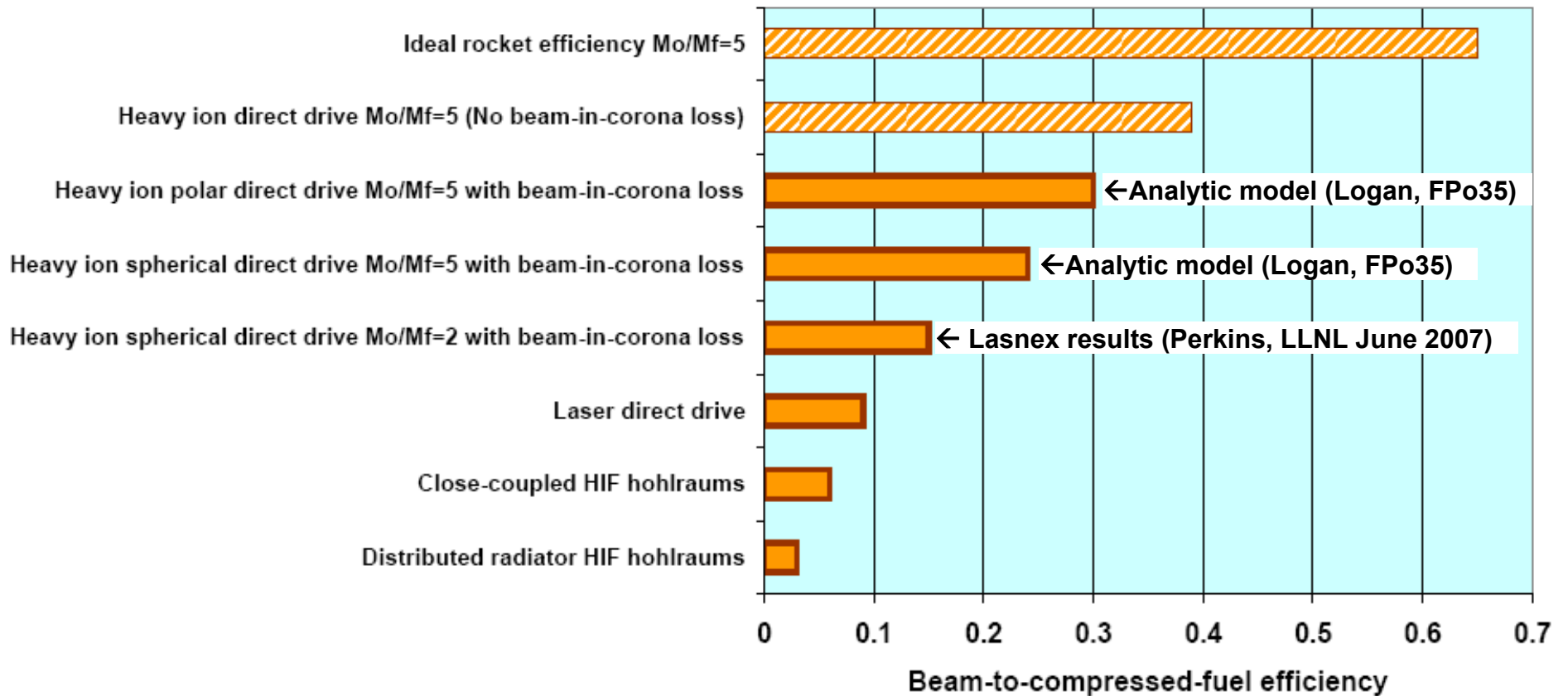

# Recent HIF target implosion calculations (John Perkins\*) using state-of-the-art codes at LLNL confirm the unique potential of HIF direct drive.

1. Overall beam-to-compressed fuel coupling efficiencies  $>15\%$ , despite major parasitic beam losses that can be further reduced by optimizing parameters in the next set of calculations.
2. Use of low range ions synergistic with neutralized beam drift compression and focusing as in current NDCX program.
3. Ion ranges set at 25% of the initial ablator thickness allows sufficient shock timing control to get low adiabat implosions  $\alpha < 1.5$  enabling gains  $> 60$  at 1MJ, higher with more fuel mass.
4. Potential example demonstrates use of a late ion-driven shock for two-step implosion and ignition benefits like fast ignition.

\*(Joint paper in progress, to be submitted to Nuclear Fusion)

→ These advances enable T-lean implosions with larger fuel masses sufficient to capture most neutron energy for low cost direct plasma MHD direct conversion. (See second talk)

# With eV-scale volumetric ion heating of foams and solids a variety of physics is opened to exploration

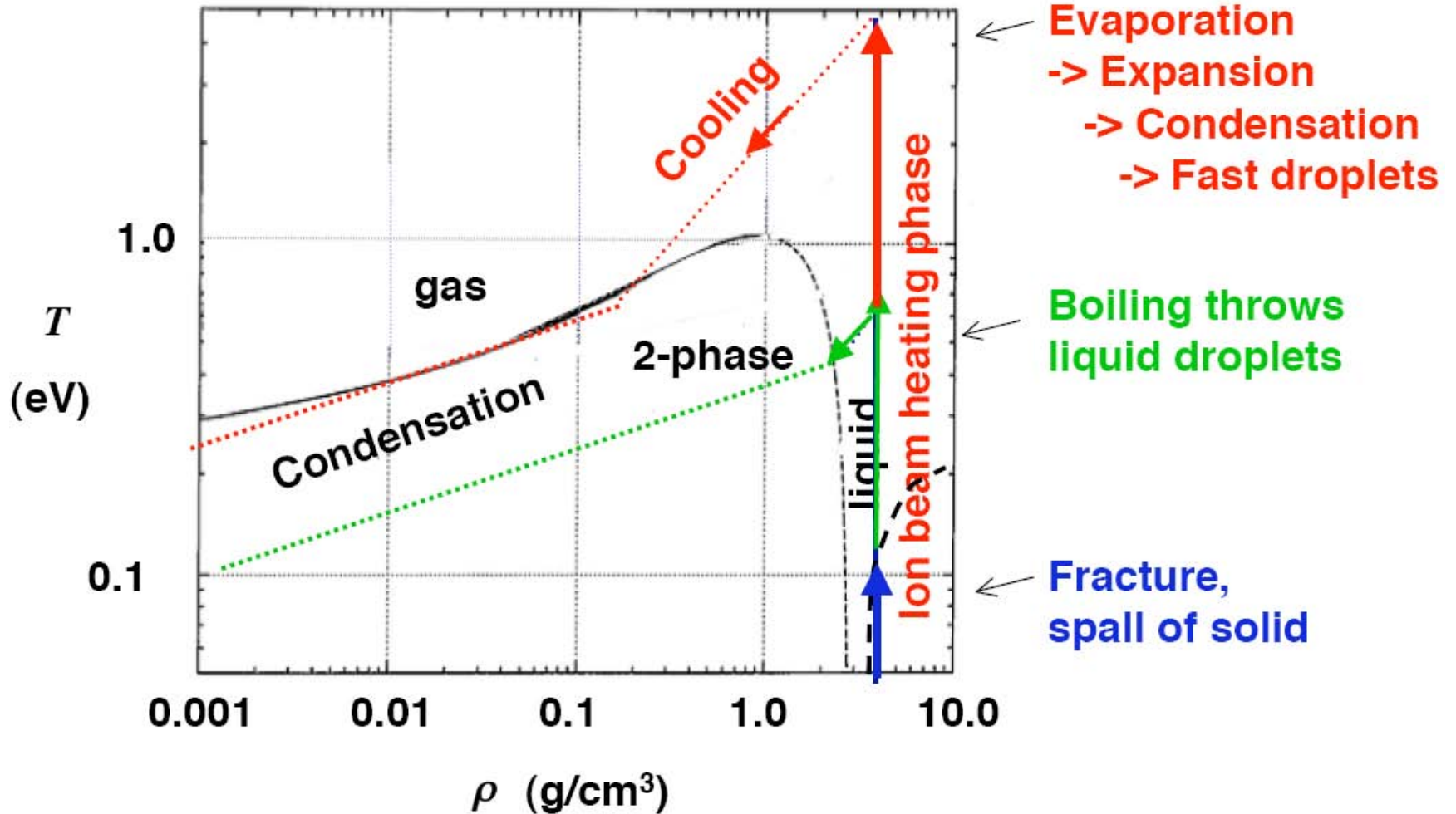

*→ These three processes need both improved WDM theory and well-characterized data, and so are early candidates for experiments and modeling!*

# Key EOS parameters we are pursuing in the Warm Dense Matter regime

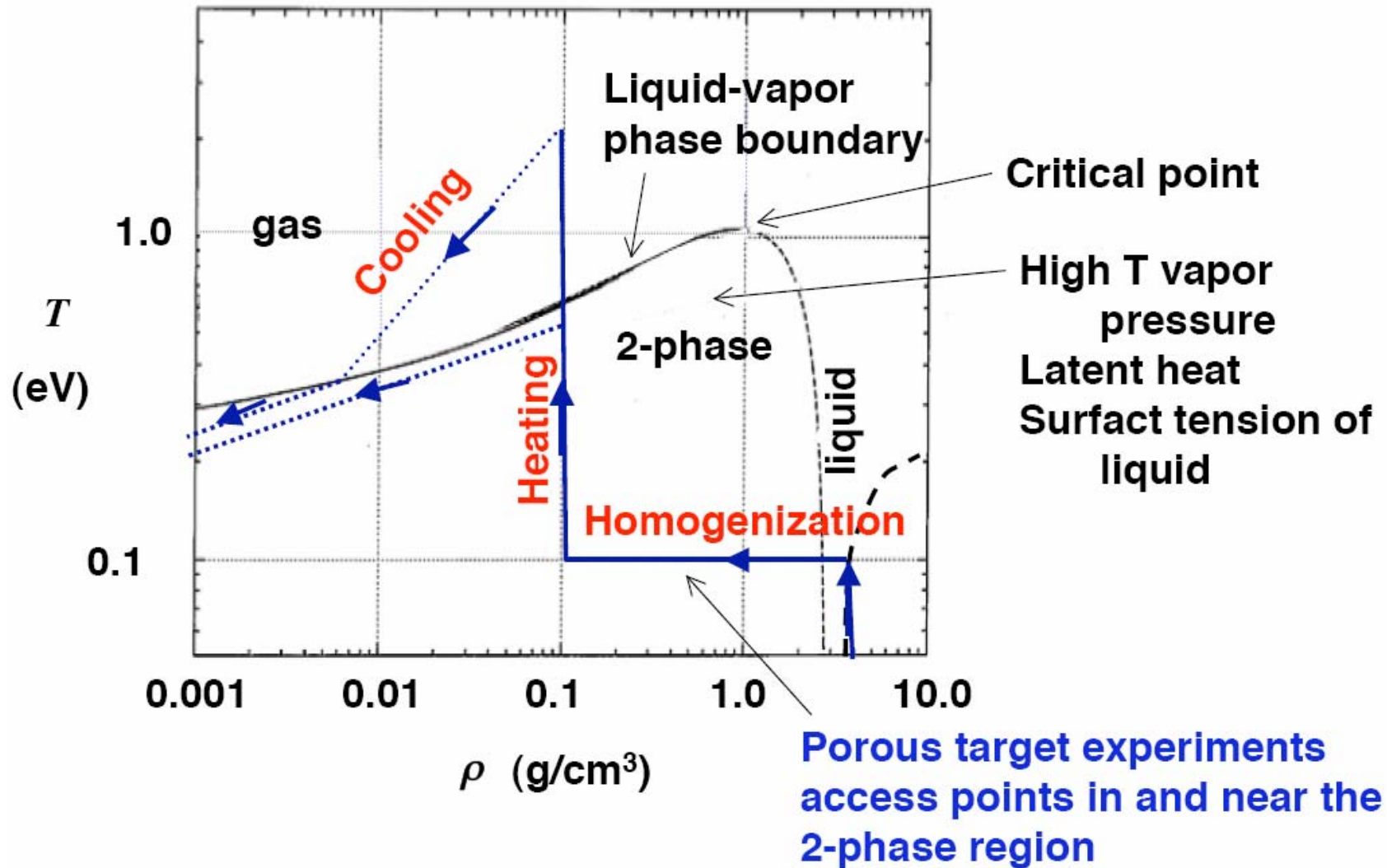

# Additional fundamental scientific opportunities of WDM

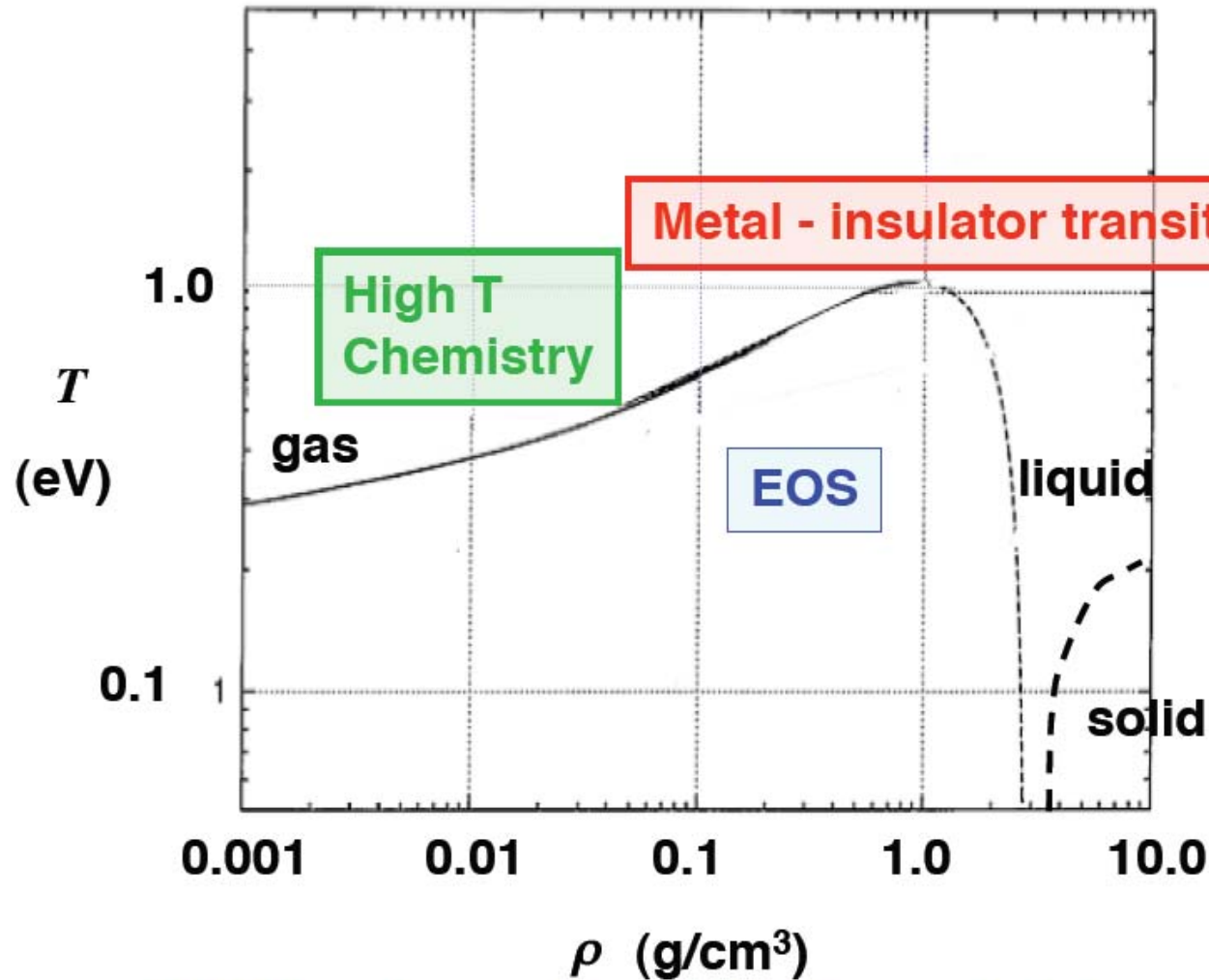

WDM is a key region of EOS uncertainty

High-T chemistry includes +/- ion Br, I plasma



## Selected scientific questions that can be pursued in NDCX-I and II (R. More, J. Barnard, F. Bieniosek)

---

1. Quartz transient darkening emission and absorption experiment.  
→ *What is the physical mechanism for changes in the optical properties of glass, as matter approaches the WDM regime?*
2. Measure target temperature, using a beam compressed both radially and longitudinally.  
→ *How can we measure the thermodynamic properties of matter, heated by ion beams compressed in space and time?*
3. Thin target  $dE/dx$ , energy distribution, charge state, and scattering in a heated target.  
→ *Can an ion beam (after it heats and exits a target) be used as a unique diagnostic tool for WDM exploration?*
4. Positive - negative halogen ion plasma experiment ( $kT > \sim 0.4$  eV)  
→ *Can unique states of matter be created with nearly equal quantities of positive and negative ions (and few electrons)?*
5. Two-phase liquid-vapor metal experiments (e.g.  $kT > 0.5 - 1$  eV for Sn)  
→ *In the two-phase regime, what is the best way to make predictive simulations of the EOS and dynamics including the effects of droplets?*

→ See 2006 international workshop on accelerator-driven warm dense matter (<http://hifweb.lbl.gov/public/AcceleratorWDM/TableOfContents.html> )

# Improving NDCX-I for FY08-09 warm dense matter experiments

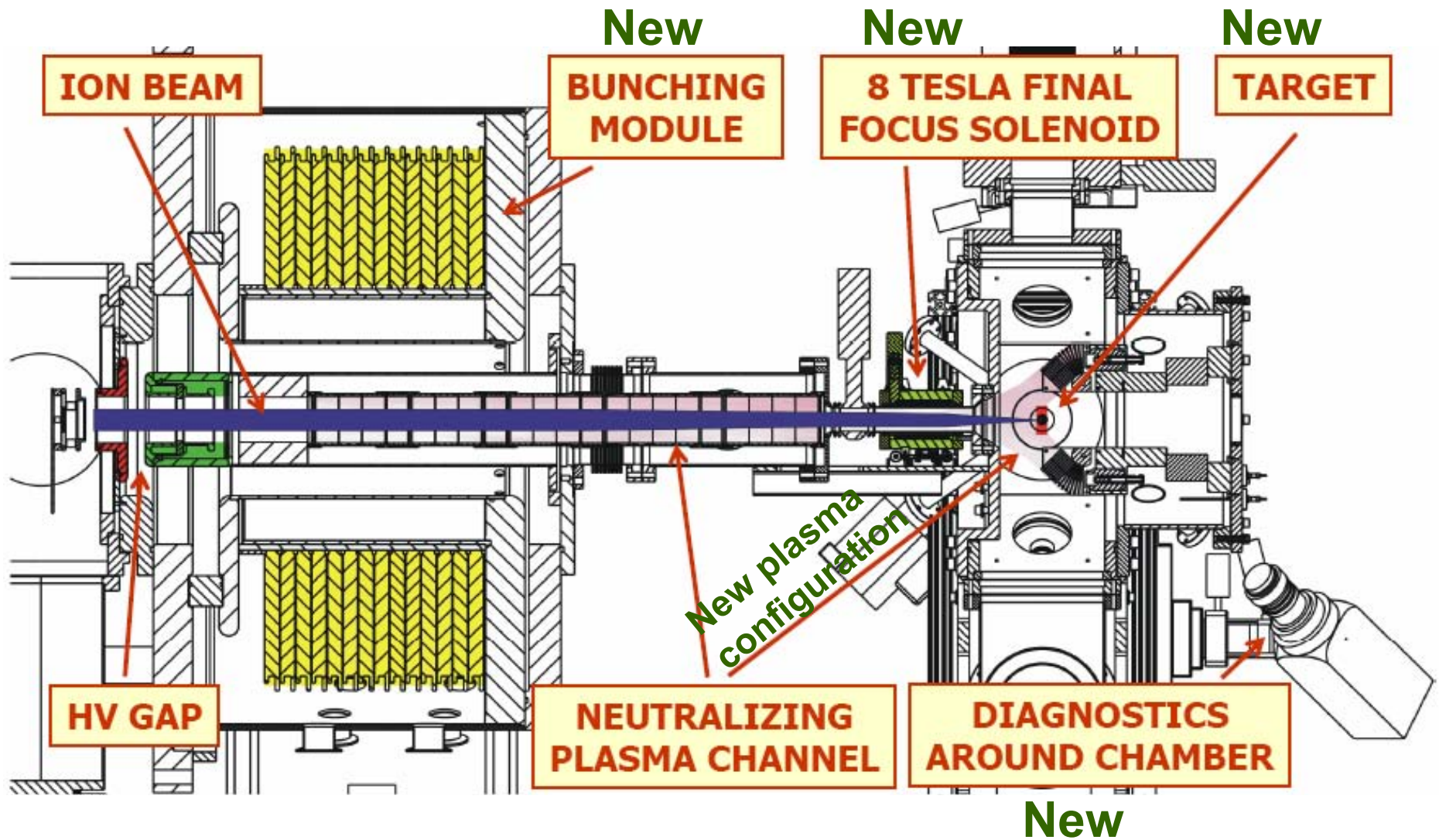

**With new improved bunching module to be installed later this year, plus a higher field 15T focusing magnet in FY09, NDCX-I is predicted to support >0.5 eV target conditions with 2 ns pulses**

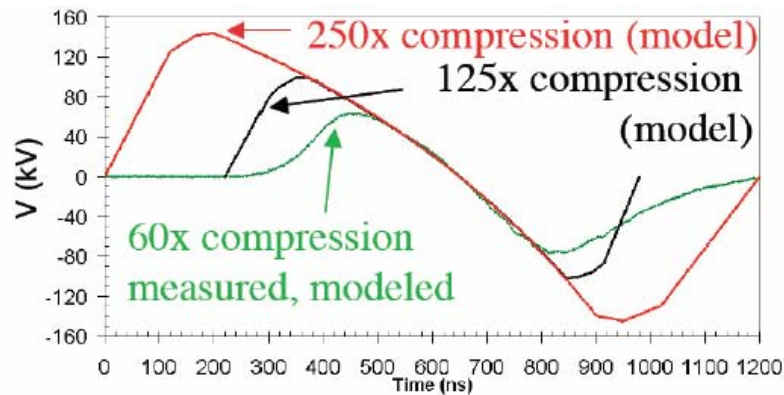

Fig. 4. The IBM for the simulation in Section II used the upgraded optimized voltage waveform (red) shown in the figure in order to apply an axial velocity tilt to the ion beam as it traverses the acceleration gap region. The existing IBM voltage waveform (green) is shown for comparison.

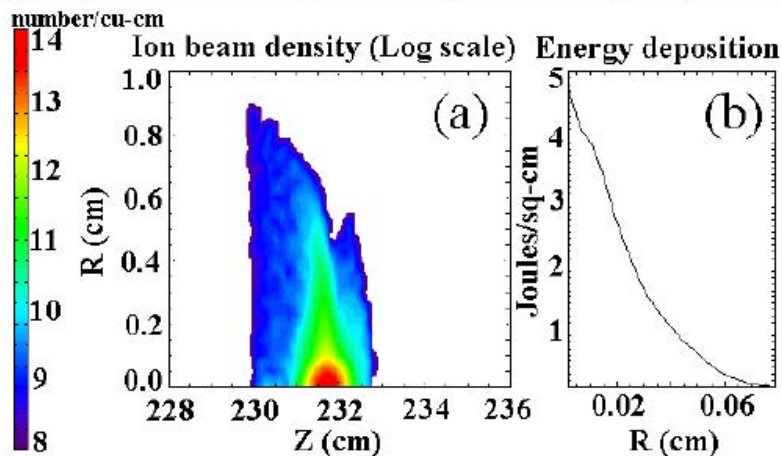
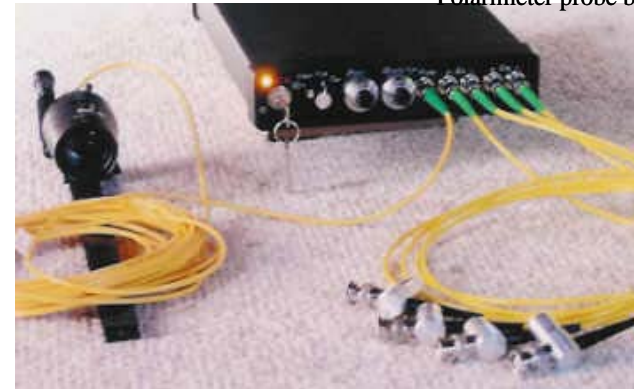
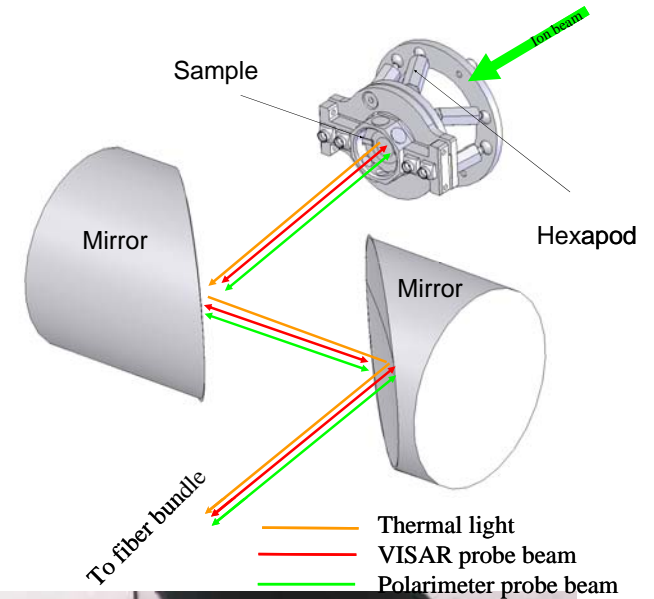

Fig. 6. Ion beam properties at the simultaneous focal plane (within a 150 kG final-focus solenoid): (a) density (log scale); and (b) radial profile of cumulative energy deposition through the focal plane.

**Actual achievable NDCX-I intensity for WDM targets in FY09 will range between > 0.15 J/cm<sup>2</sup> (previous slide) and this simulation of best possible case < 4 J/cm<sup>2</sup> .**

# Initial NDCX-I Target diagnostics

- **Fast optical pyrometer**
  - Similar to GSI pyrometer, improved for faster response ( $\sim 1$  ns) and greater sensitivity
  - Temperature accuracy 5% for  $T > 1000$  K
  - Position resolution about 400 micron
  - *Parts are being ordered – to be assembled in FY07*
- **Fiber-coupled VISAR system – *now under test***
  - Martin Froescher & Associates
  - Sub-ns resolution
  - 1% accuracy
- **Hamamatsu visible streak camera with image intensifier**
  - Sub-ns resolution
  - *arrived Feb. 2007*



# Diagnostic development and testing: VISAR for NDCX-I

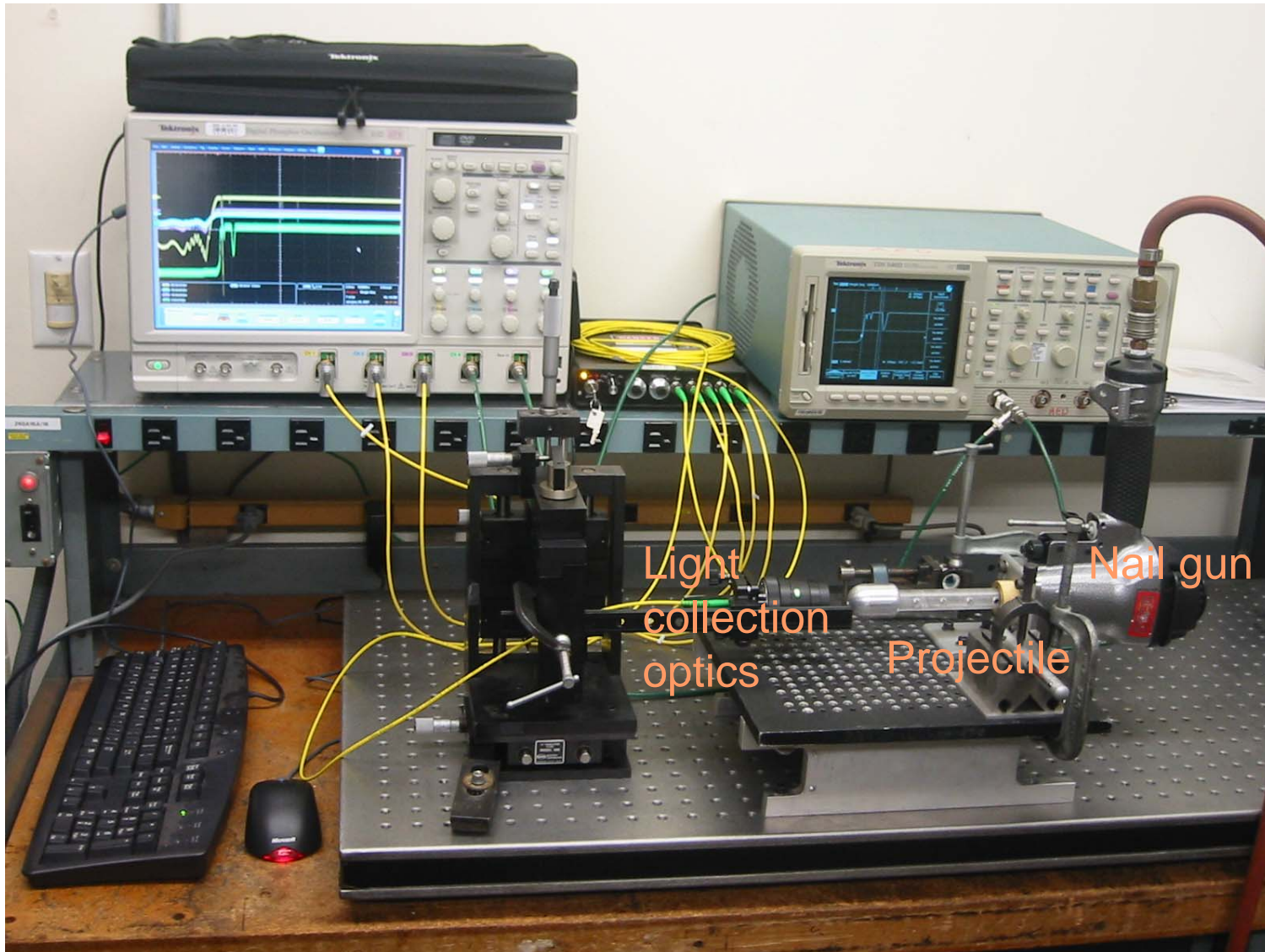

# VNL porous target experiments at GSI have already begun

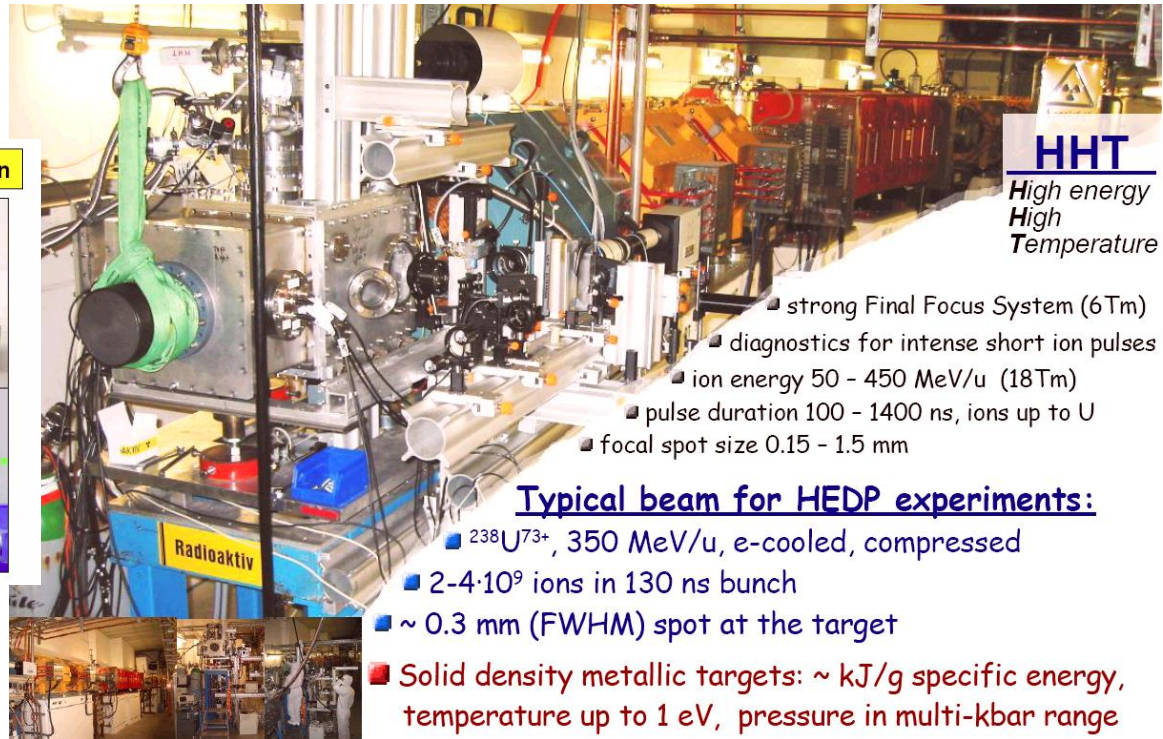
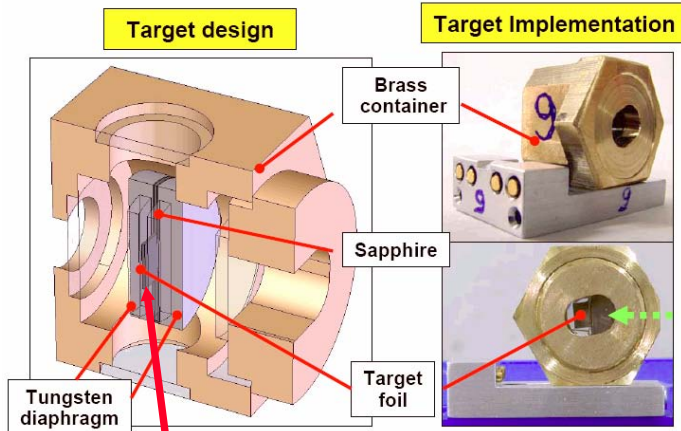

**HHT**

High energy  
High  
Temperature

- strong Final Focus System (6Tm)
- diagnostics for intense short ion pulses
- ion energy 50 - 450 MeV/u (18Tm)
- pulse duration 100 - 1400 ns, ions up to U
- focal spot size 0.15 - 1.5 mm

## Typical beam for HEDP experiments:

- $^{238}\text{U}^{73+}$ , 350 MeV/u, e-cooled, compressed
- $2\text{-}4 \cdot 10^9$  ions in 130 ns bunch
- $\sim 0.3$  mm (FWHM) spot at the target
- Solid density metallic targets:  $\sim$  kJ/g specific energy, temperature up to 1 eV, pressure in multi-kbar range

- Replace target foil with porous material.
- Study effect of pore size on target behavior using existing diagnostics.
- Sample targets: LLNL (Au, 50 nm), Mitsubishi (Cu, 50 micron).

## Data analysis from GSI experiments is underway (Bieniosek)

- Gold targets heated to about 6000 K ( $T_{\text{boil}} = 2435$  K). Solid and porous gold targets show similar behavior (temp, 1.4 km/s expansion).

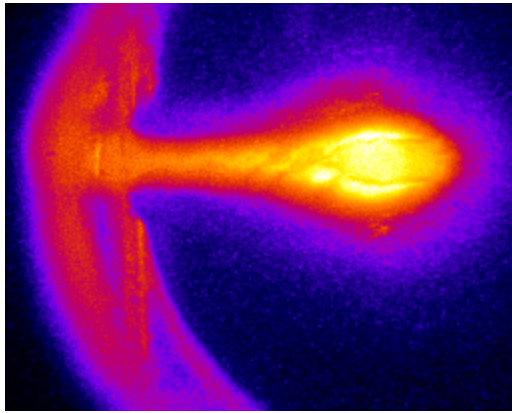

solid gold (note Bragg peak)

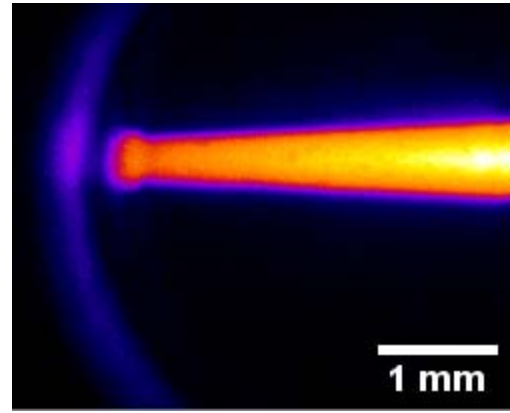

Porous gold

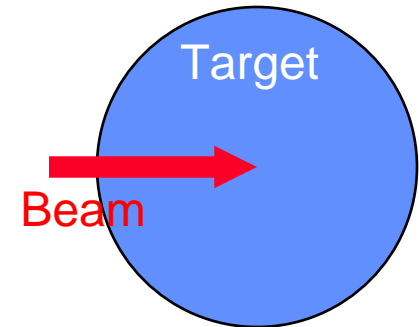

- Copper targets heated to about 3000 K ( $T_{\text{boil}} = 3200$  K). Porous copper broke up into droplets.

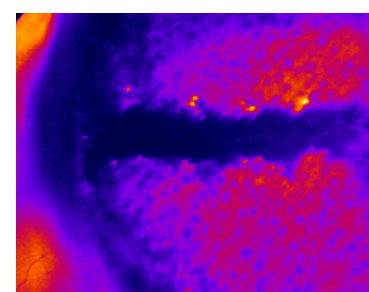
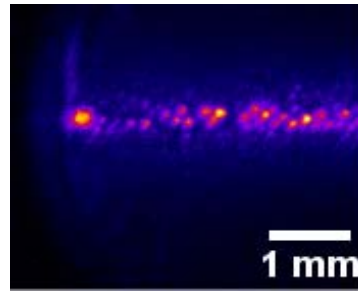
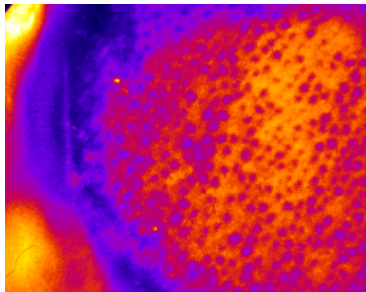

Porous copper – before, during, after beam pulse

# NDCX-II is the next step towards IB-HEDPX as well as towards a heavy-ion-fusion direct drive capability following NIF ignition

## GOALS FOR NDCX-II:

- Integrated compression, acceleration, and focusing sufficient to reach 1 eV in targets and to drive hydrodynamics experiments relevant to asymmetric direct drive heavy ion fusion.
- Incorporate short-pulse injector to minimize accelerator cost
- Diagnostics, target, and target chamber development for IB-HEDPX user facility to be constructed after NDCX-II, and for future heavy ion fusion direct-drive capability

## TARGET POINT DESIGN:

Bragg Peak:	1.8 MeV
dE/dx at Bragg Peak:	2 MeV cm <sup>2</sup> / mg
Ion Range:	~5 micron
Required Fluence for > 1 eV Heating:	>29 J/cm <sup>2</sup>

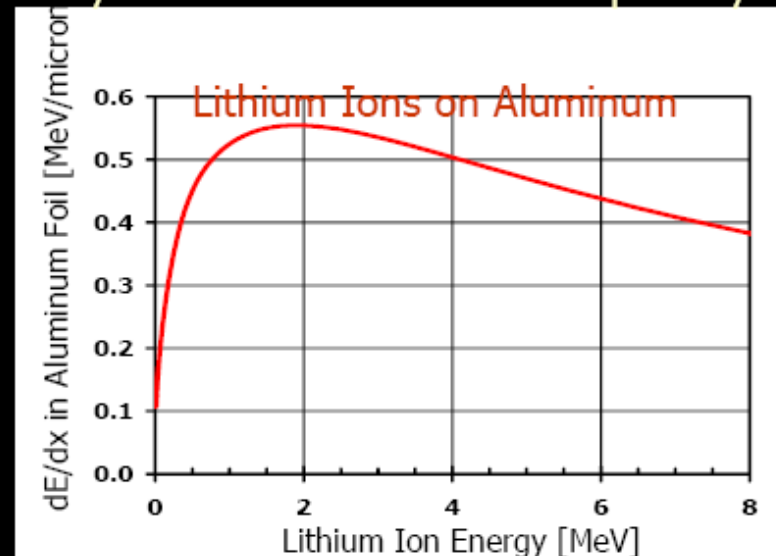



# LLNL has donated 30 surplus ATA induction modules now located at LBNL- sufficient for NDCX-II

30 ATA Induction Cells = 6 MeV

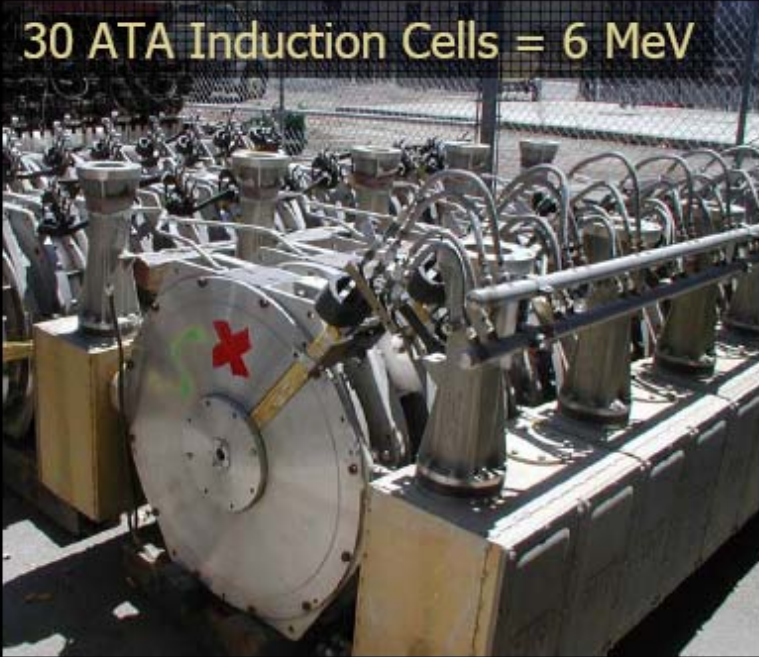

ATA Transformers & Blumleins also



NDCX-1 Beamline Solenoid Winding ~NDCX-II size

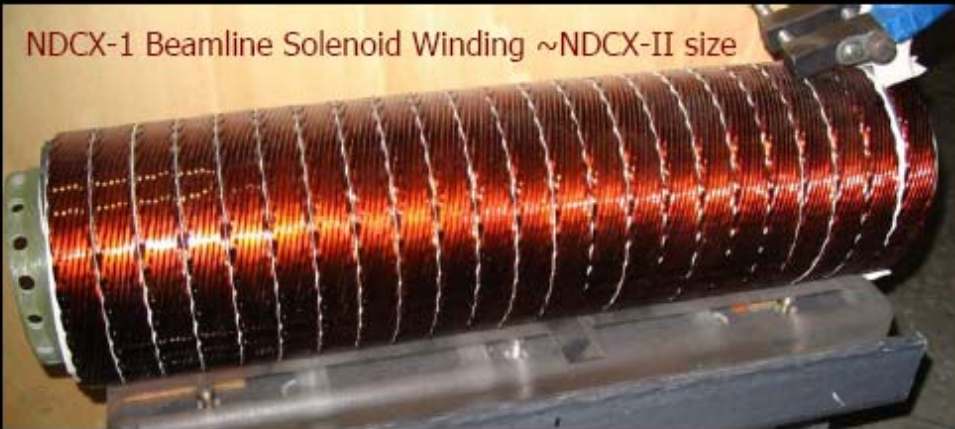

- We have shipped hardware for 30 induction cells to LBNL.
- We are building a high-field pulsed solenoid to fit into an ATA induction cell for tests.
- Hardware for two cell units has been refurbished for testing.

# NDCX-II TARGET POINT DESIGN AND DRIVER REQUIREMENTS FOR $>1$ eV TARGET HEATING

7

## ALUMINUM TARGET FOIL

Thickness (for  $<5\%$   $\Delta T$ ):

**$\sim 3$  micron**, solid density foil

**$\sim 25$  micron**, 10% solid density foam

## LITHIUM ION BEAM BUNCH

Final Beam Energy:

**2.8 MeV**

Final Spot Size :

**$<1$  mm diameter**

Final Bunch Length:

**$<1$  ns** ( $\cong <1$  cm)

Total Charge Delivered:

**0.03 micro-Coulomb** ( $I_{\max} \sim 42$  A)

Normalized Emittance:

**0.4 pi-mm-mrad**

Exiting Ion Beam Available  
for dE/dx Measurement

# NDCX-2 TESTSTAND IS CURRENTLY UNDER CONSTRUCTION TO VERIFY CELL PERFORMANCE AND TO TEST HIGH FIELD SOLENOID

16

STATUS 1/24/2007

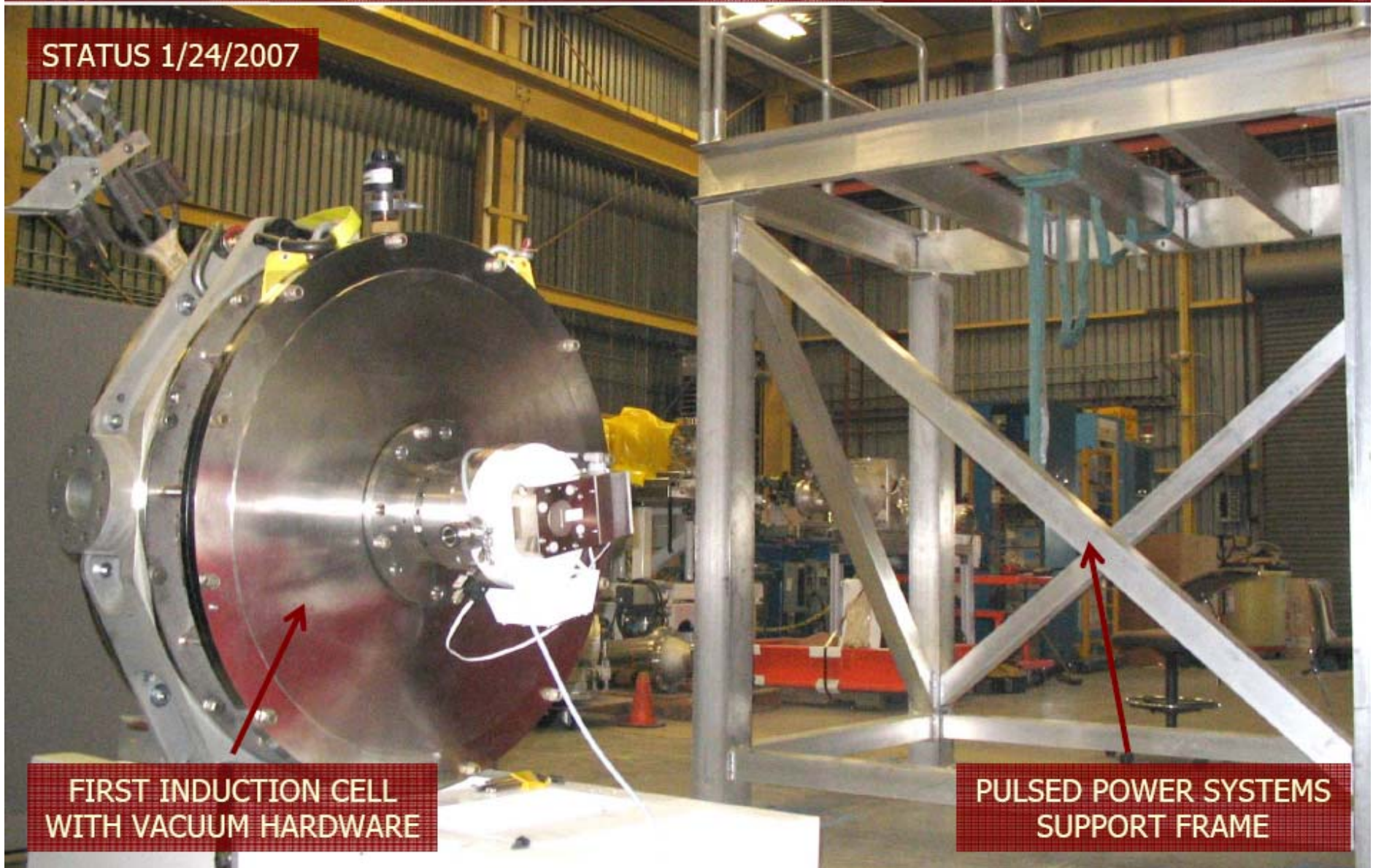

FIRST INDUCTION CELL WITH VACUUM HARDWARE

PULSED POWER SYSTEMS SUPPORT FRAME

## **For a very modest investment of \$1.5M, the NDCX-II accelerator can be assembled and offer high shot rates available for HEDLP science users:**

- **Precise control of beam energy deposition**
- **5 % uniformity over large sample sizes ~ mm<sup>2</sup>**
- **Pulses long enough to achieve local thermodynamic equilibrium**
- **Maximum # of NDCX experiments ~100's of shots per day for user-available targets, ~ 500 more/day for beam/diagnostic tune-up.**
- **Benign environment (no intense x-rays or neutrons that require shielding for people or diagnostics)**
- **NDCX-I-II would be dedicated to HEDLP users-not encumbered by other programmatic priorities**
- **Easily accessible site to visiting scientists and students**

# POSSIBLE NDCX-2 SCHEDULE

(PRESIDENT'S BUDGET DOES NOT CURRENTLY SUPPORT NDCX-2 CONSTRUCTION)

## NDCX-1

- (1) COMPRESSION IMPROVEMENT CAMPAIGN
- (2) TARGET EXPERIMENTS
- (3) TIME DEPENDENT FOCUSING EXPERIMENTS
- (4) PLASMA SOURCE IMPROVEMENT
- (5) HYDRO EXPANSION AND TARGET TEMPERATURE MEASUREMENTS

## NDCX-2

- (1) CONCEPTUAL DESIGN
- (2) INJECTOR
- (3) INJECTOR SOLENOIDS
- (4) PRE-BUNCHING SECTION
- (5) ACCELERATOR
- (6) DRIFT BUNCHING MODULE (EXISTING)
- (7) DRIFT COMPRESSION
- (8) TARGET CHAMBER INCL. MAGNET (EXISTING)
- (9) CONTROLS
- (10) SUPPORT HARDWARE
- (11) DOUBLE PULSING HARDWARE
- (12) SUPERCONDUCTING FF SOLENOID

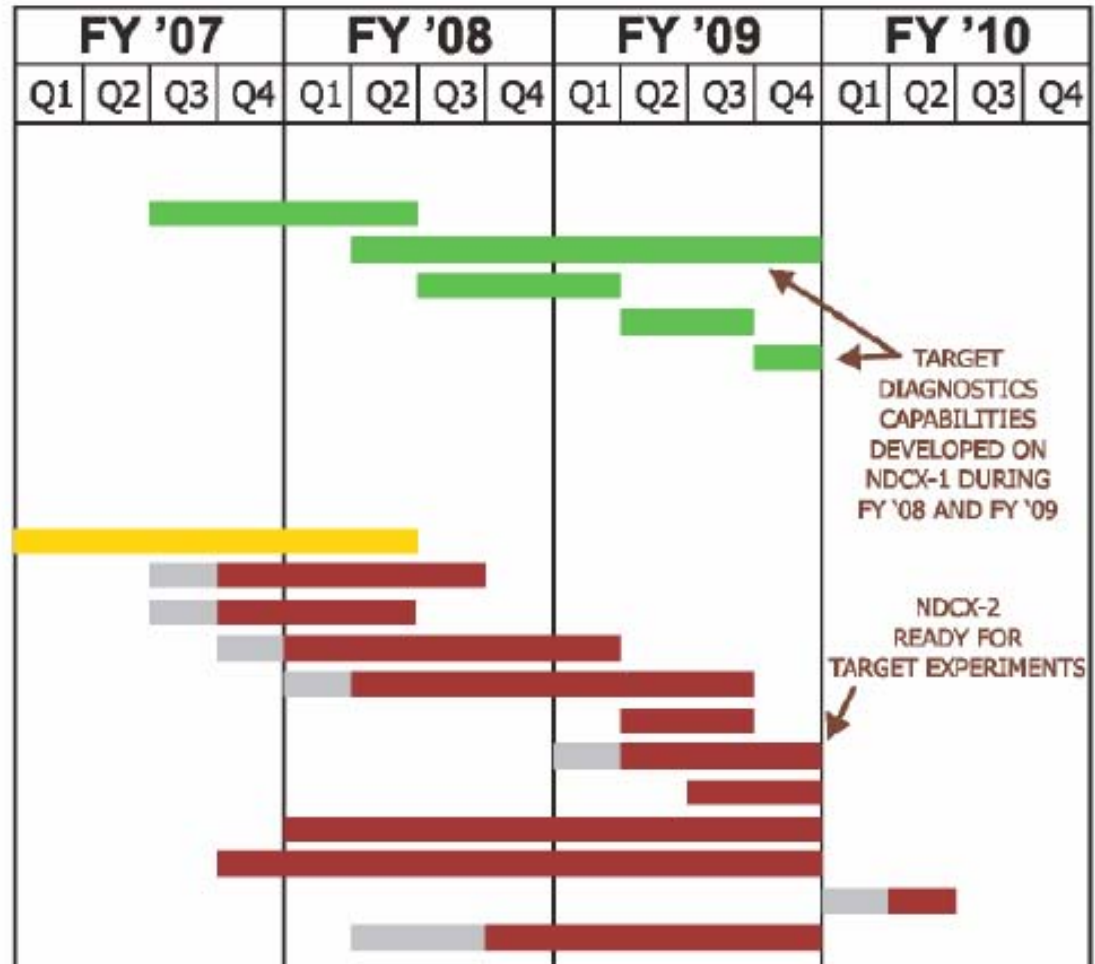

**→ Requires \$1.5M incremental funding for hardware to complete**